

## Full Length Research Paper

# Moisture dependent physical properties of fennel seeds

S. Shafiee<sup>1\*</sup>, A. Modares Motlagh<sup>2</sup> and S. Minaei<sup>3</sup>

<sup>1</sup>Msc student in Urmia University, Urmia, Iran.

<sup>2</sup>Agricultural Machinery Department, Faculty of Agricultural Engineering, Urmia University, Iran.

<sup>3</sup>Agricultural Engineering Center of Excellence, Recycling and Reduction of Losses of Agricultural Products, Tarbiat Modares University, Iran.

Accepted 2 July, 2010

**Physical properties of fennel seeds were determined at five levels of moisture content. All dimensions of seed increased with increasing moisture content from 7.57 to 52.88% (dry base). At the same moisture range, sphericity, surface area and true density increased from 41.60 to 44.10%, 8.39 to 9.47 mm<sup>2</sup>, and 818.29 to 894.63 kg m<sup>-3</sup>, respectively. In this moisture range, bulk density decreased from 376.27 to 314.667 kg m<sup>-3</sup> whereas the angle of repose and porosity increased from 36.33 to 48.66 and 54 to 64.8%, respectively. The static coefficient of friction of seeds increased linearly against surfaces of three structural materials, namely, glass, plywood, and galvanized iron.**

**Key words:** Sphericity, surface area, angle of repose, static coefficient of friction, bulk and true densities.

## INTRODUCTION

Fennel is a member of the Apiaceae (carrot or parsley) family and is related to cumin, dill, caraway and anise, all bearing aromatic fruits that are commonly called seeds. It is native to southern Europe but it is now cultivated in Northern Europe, Australia, North America and around the world. Fennel seeds (Figure 1) are baked into bread, biscuits, stuffings, Italian sausages, and added to sweet pickles and sauerkraut.

Seeds complement asparagus, tomato and cucumber. The essential oil from the seeds is added to perfumes, soaps, pharmaceuticals and cosmetics (<http://www.herbsociety.org>). Fennel oil, seeds or extracts are also used to flavor prepared foods including meats, ice cream, candy, baked goods and condiments as well as liqueurs like sambuca, non-alcoholic beverages and toothpaste. Fennel is GRAS (Generally Recognized as Safe) at 50 - 6500 ppm, and the essential oil is GRAS at 0.3 - 234 ppm. Oil is reportedly antioxidant, antimicrobial, antispasmodic, and stimulates gastrointestinal motility. Studies on physical properties were reported for various crops such as hemp seed (Sacilik et al., 2003); fenugreek seeds (Altuntaş et al., 2005); lentil seeds (Amin et al.,

2004); guna seeds (Aviara et al., 1999); millet (Baryeh, 2002); sunflower seeds (Baümler et al., 2006); and linseed (Selvi et al., 2006). Knowledge of the physical properties of fennel seeds is essential to facilitate and improve the design of equipment for handling, harvesting, processing, and storing the seed. Various types of cleaning, grading and separation equipment may be designed on the basis of the physical properties of the seed. The purpose of this study is to determine some moisture-dependent physical properties of fennel seed, namely, size, sphericity, surface area, bulk density, true density, porosity, angle of repose, and the static coefficient of friction in the moisture range from 7.57 - 52.88% d.b.(dry base).

## MATERIALS AND METHODS

Fennel seeds used in this study were obtained from the local market in Urmia, Iran. The samples were cleaned manually to get rid of all foreign matter, broken, and immature seeds. Initial moisture content of the seeds was determined to be 7.57% (d.b), by oven drying at 105±1 °C for 24 h (Selvi et al., 2006). The fennel seeds at different moisture levels were prepared by adding calculated quantity of water mixing thoroughly and then sealing in separate polyethylene bags. The seeds were kept at 5°C in a refrigerator for a week to allow the moisture to distribute uniformly throughout the sample. Before each test, the required quantities of the samples were taken out of the refrigerator and allowed to warm

\*Corresponding author. E-mail: [s.shafiee80@gmail.com](mailto:s.shafiee80@gmail.com). Tel: 98-841-2225973. Fax: 98-441-2779558.



Figure 1. Fennel seeds.



Figure 2. Apparatus to determine coefficient of static friction.

up to room temperature. All physical properties of the seeds were determined at moisture contents of 7.57, 17.25, 25.16, 35.14 and 52.88% (d.b.). To determine the length, width and thickness of seeds in each moisture content, samples of 50 seeds were randomly selected.

Materials (seeds) were measured by a micrometer caliper with an accuracy of 0.01 mm. The geometric mean diameters ( $D_g$ ) the arithmetic mean diameter ( $D_a$ ) mm and sphericity( $\phi$ ) the seeds were calculated using the following equations (Mohsenin, 1970):

$$D_g = (abc)^{1/3} \quad (1)$$

$$D_a = \left( \frac{a+b+c}{3} \right) \quad (2)$$

$$\phi = \frac{(abc)^{1/3}}{a} \quad (3)$$

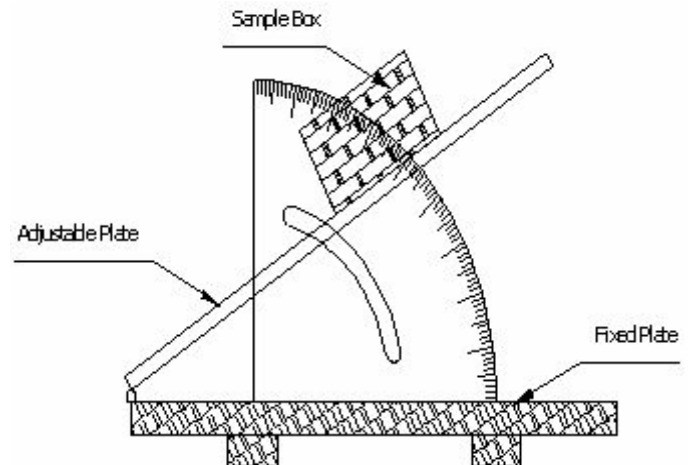

Figure 3. Apparatus to determine angle of repose.

Where  $a$  is the length,  $b$  is the width and  $c$  is the thickness, all in mm.

Seed surface area was measured by comparison with a sphere of the same geometric mean diameter, using the equation cited by Saçilik (2003), Tunde-Akintunde and Akintunde (2004) and Altuntaş et al. (2005):

$$S = \pi D_g \quad (4)$$

Where  $s$  is the surface area in  $\text{mm}^2$ .

True density of a seed is defined as the ratio of the mass of a sample of a seed to soiled volume occupied by the sample. It was determined using the toluene displacement method (Mohsenin, 1986). Bulk density is the ratio of the mass of a sample of seeds to its total volume. This was determined by filling an Aluminum's container of 10 cm height and 5 cm diameter with seed from a constant height, striking the top level and then weighing the constants (Deshpande et al., 1993; Gupta and Das, 1997; Konak et al., 2002; Paksoy and Aydin, 2004). Porosity of bulk seeds was calculated from bulk and true densities using the relationship given by Mohsenin (1970), as follows:

$$\varepsilon = \left( 1 - \frac{\rho_b}{\rho_t} \right) 100 \quad (5)$$

Where,  $\varepsilon$  is the porosity in %;  $\rho_b$  is the bulk density in  $\text{kg.m}^{-3}$ ; and  $\rho_t$  is the true density in  $\text{kg.m}^{-3}$ .

The coefficient of static friction was determined against different surfaces: plywood, glass, and galvanized iron. A hollow metal cylinder (Figure 2) of diameter 75 mm and 50 mm depth, opened at both ends, was filled with the seeds at the desired moisture content and placed on an adjustable tilting surface in such a way that the metal cylinder did not touch the surface. Then the surface was raised gradually until the filled cylinder just started to slide down (Razavi and Milani, 2006).

The static angle of repose is the one with the horizontal at which the material will stand when piled. This was determined through the use of the apparatus (shown in Figure 3) consisting of a plywood box of  $140 \times 160 \times 35$  mm and two plates: fixed and adjustable. The

**Table 1.** Means and standard errors of the axial dimensions of fennel seeds.

M.C. (%)	a (mm)	b (mm)	c (mm)	D <sub>a</sub> (mm)	D <sub>g</sub> (mm)
7.57	0.012 ± 6.11	0.005 ± 1.8	0.004 ± 1.66	3.22	2.67
17.25	0.01 ± 6.25	0.004 ± 1.86	0.004 ± 1.76	3.29	2.72
25.16	0.009 ± 6.46	.005 ± 1.95	0.004 ± 1.83	3.38	2.79
35.14	0.011 ± 6.91	0.005 ± 1.99	0.005 ± 1.83	3.61	2.96
52.88	± 0.0367.86	0.005 ± 2.05	0.007 ± 1.91	3.91	3.02

M.C is moisture content. a, b, c are length width, and thickness respectively. D<sub>a</sub> and D<sub>g</sub> are arithmetic mean diameter and geometric mean diameter, respectively.

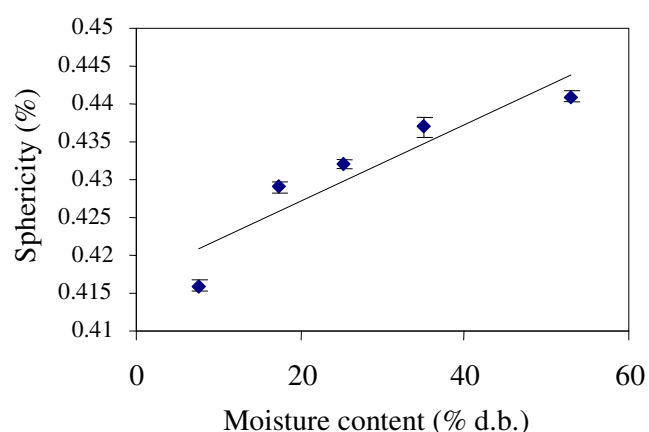
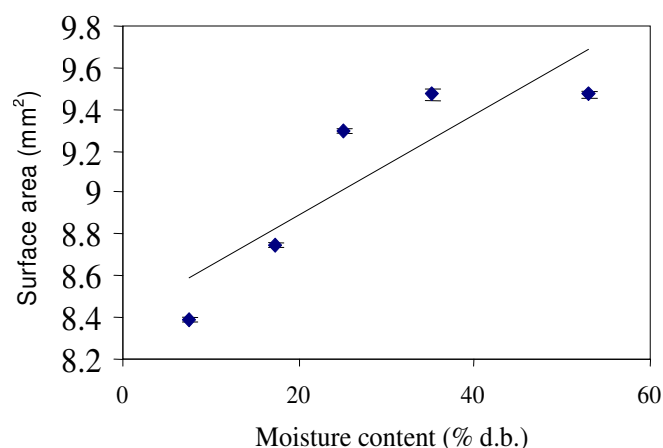
**Figure 4.** Effect of moisture content on sphericity of fennel seed.**Figure 5.** Seed surface area variations with moisture content.

box was filled with the sample, and then the adjustable plate was inclined gradually allowing the seeds to flow and assume a natural slope (Tabatabaefar, 2003).

## RESULTS AND DISCUSSION

Means and standard errors of the axial dimensions of fennel seeds at different moisture contents are given in Table 1. It demonstrates that when the moisture content of seed increased from 7.57 to 52.88% (d.b.), the average length, width, and thickness of seeds increased to 7.86, 2.05, and 1.91 mm, respectively. ANOVA results showed that the differences between moisture levels were statistically significant ( $P < 0.01$ ) for the three axes. These results were similar to those reported by Selvi et al. (2006) for linseed.

Average diameters calculated by the arithmetic mean and geometric mean formula are also presented in Table 1. The average diameters increased with increasing moisture content. The dimensional increases in major, medium and minor were 28, 13.8 and 15.06%, respectively. The arithmetic and geometric mean diameters ranged from 3.22 - 3.91 mm and 2.67 - 3.02 mm as the moisture content increased from 7.57 to 52.88%. The total average expansion was the most along the grain

length and the least along its width. Similar trends were reported for millet seeds (Baryeh, 2002).

Seed sphericity increased from 41.6 to 44.1% when moisture content increased from 7.57 to 52.88% d.b. (Figure 4). A similar trend has been reported by Baumler et al. (2006) for safflower seeds, Selvi et al. (2006) for linseed, Altuntaş and Yildiz (2007) for Faba bean grain, and Aydin et al. (2002) for Turkish Mahaleb seeds.

The surface area of seeds (Figure 5) increased linearly while the moisture content increased from 7.57 to 52.88% (d.b.) Variation of moisture content with surface area can be expressed by the following equation:

$$S = 0.043M + 8.19 \quad R^2 = 0.84 \quad (6)$$

Similar trends have been reported by Baryeh (2002) for millet, Aviara et al. (1999) for guna seed, Sacilik et al. (2003) for hemp seed, and by Selvi et al. (2006) for linseed.

The bulk density of fennel seeds at different moisture levels as presented in Figure 4, varied from 376.27 to 314.67 kg.m<sup>-3</sup> (Figure 6). Results showed a decrease in bulk density by increasing moisture content from 7.57 to 52.88% (d.b.). Variation of bulk density with moisture content was linear as shown in Figure 5, and can be expressed by the following linear relationship:

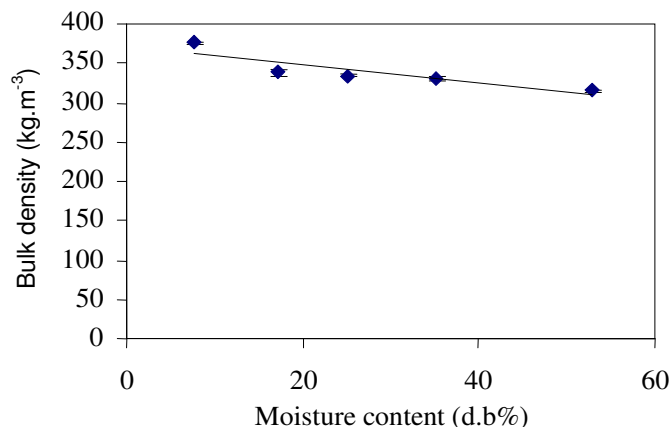

**Figure 6.** Moisture content-bulk density relationship for fennel seed.

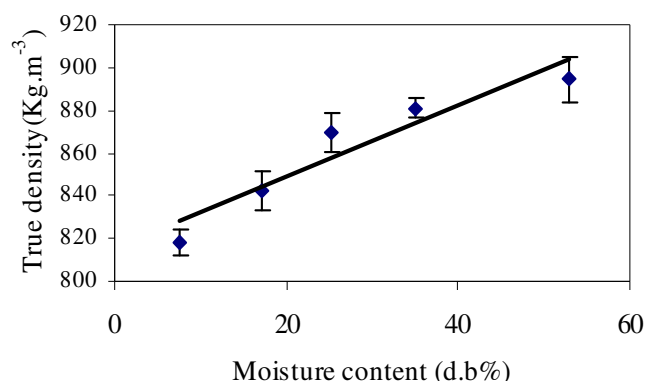

**Figure 7.** Moisture content dependence of true density of fennel seed.

$$\rho_b = 380.06 - 1.99M \quad R^2 = 0.84 \quad (6)$$

The negative linear relationship of bulk density with moisture content was also observed by various researchers (Dursun and Dursun, 2005; Altuntaş et al., 2005). The decrease in bulk density with increased moisture content indicates that the sample is lower than the accompanying volumetric expansion of bulk.

Seed true density varied from 818.29 to 894.64 kg.m<sup>-3</sup> when moisture content increased from 7.57 to 52.88% d.b. (Figure 7). Seed true density and moisture content can be correlated as follows:

$$\rho_t = 802.23 + 2.87M \quad R^2 = 0.95 \quad (7)$$

The increase in true density of seeds together with the increase in moisture content showed that the increase in weight gain is greater than the volume increase. This is in agreement with the finding of Baryeh (2002), Coşkun et al. (2005), Selvi et al. (2006), Dursun and Dursun (2005) and Altuntaş and Yıldız (2007).

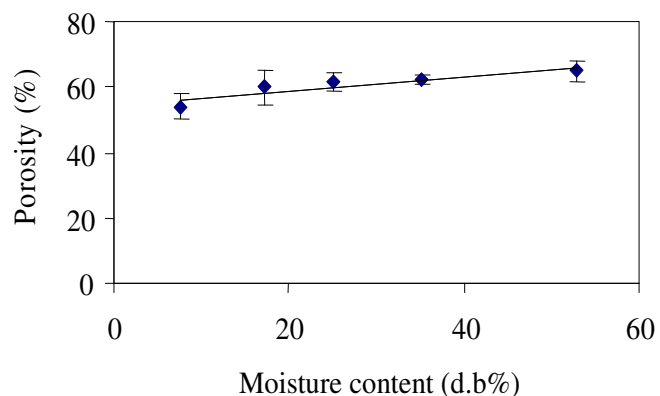

**Figure 8.** Effect of moisture content on porosity of fennel seed.

Porosity was calculated from equation (5) using the data on bulk and true densities of the fennel seed. Variations of porosity with moisture content are shown in Figure 8. The porosity values of fennel at moisture contents between 7.57 and 52.88% varied between 54 and 64.8%. Since porosity depends on the bulk and true densities, the magnitude of variation in porosity depends on these densities only. The relationship between porosity value and moisture content was found as follows:

$$\varepsilon = 52.95 + 0.367M \quad R^2 = 0.89 \quad (9)$$

Selvi et al. (2006) showed that as the moisture content increased, seed porosity also increased for linseed. Coşkun and Karababa (2007) obtained the same result for flaxseed, but other researchers have reported the opposite result for Cuper, karingda, and chick pea (Dursun and Dursun, 2005; Suther and Dus, 1996; Konak et al., 2002).

Variations of the angle of repose  $\theta$  (in degrees) with respect to moisture content are plotted in Figure 7 as the angle of repose increased linearly from 36.33 to 48.66° with an increase in moisture content from 7.57 to 52.88% d.b. The relationship between moisture content and angle of repose can be demonstrated by the following equation:

$$\theta = 34.19 + 0.456M \quad R^2 = 0.93 \quad (10)$$

A linear increase in the angle of repose with increasing seed moisture content has also been noted by Gupta and Das (1997), Amin et al. (2004), and Selvi et al. (2006) for sunflower seed, lentil seed, and linseed, respectively.

The static coefficient of friction for fennel seed, determined against three different structural surfaces, is given in Figure 9. It was observed that the static coefficient of friction on all surfaces increases with increasing in moisture content. This can be due to the increased adhesion between the seed and the surface at higher moisture values. Similar results have also been

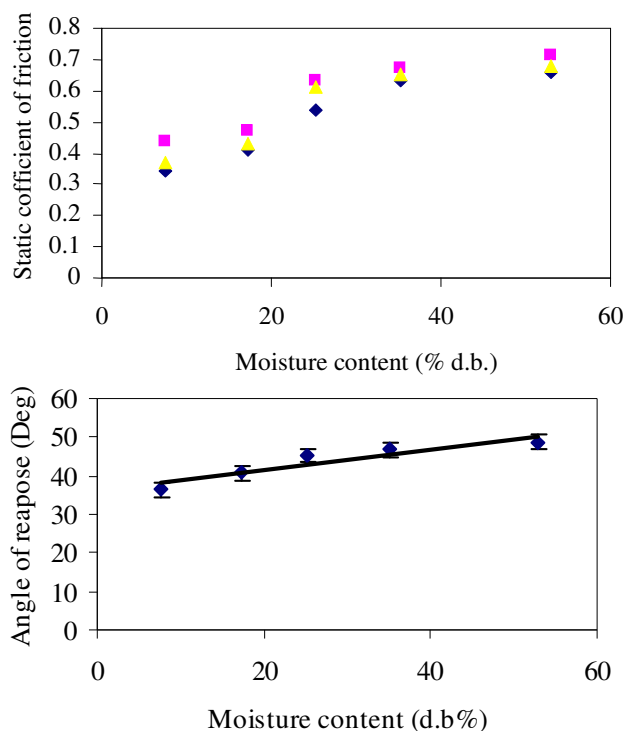

**Figure 9.** Change of Fennel seeds angle of repose with increasing moisture content.

reported by other researchers (Çarman, 1996; Suthar and Das, 1996; Nimkar and Chattopadhyay, 2001; Konak et al., 2002). At all moisture contents, the static coefficient of friction was greatest against plywood (0.44 - 0.71), followed by galvanized iron (0.37 – 0.68) and glass (0.34 – 0.66). This indicates smaller coefficient of friction values on smoother, more polished surfaces. The relationship between moisture content and static coefficients of friction on the three test surfaces can be shown by the following linear equations:

$$\mu_{pw} = 0.0357 + 0.011M \quad (12)$$

$$\mu_{gi} = 0.292 + 0.012M \quad (13)$$

$$\mu_{gl} = 0.25 + 0.013M \quad (14)$$

Where,  $\mu_{pw}$ ,  $\mu_{gi}$  and  $\mu_{gl}$  refer to coefficients of friction on plywood, galvanized iron sheet and glass, respectively. The values of the coefficient of determination ( $R^2$ ) for  $\mu_{pw}$ ,  $\mu_{gi}$  and  $\mu_{gl}$  are 0.89, 0.87 and 0.93, respectively.

## Conclusion

Selected physical properties of fennel seeds as influenced by moisture contents ranging from 7.57 to 52.88% (d.b) were investigated. Results showed that average length, width, and thickness increased with the

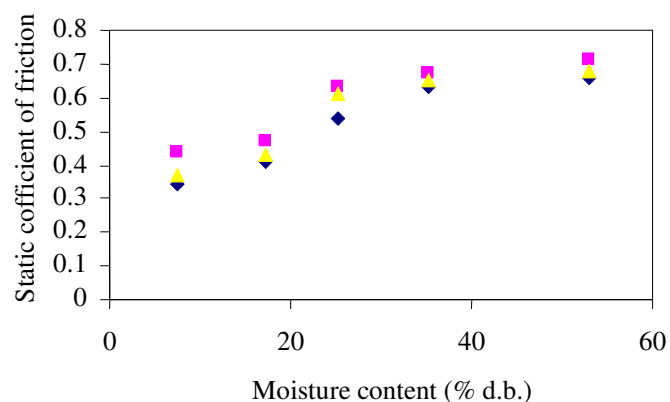

**Figure 10.** Effect of moisture content on static coefficient of friction: (◇) glass; (Δ) galvanized iron; (□) plywood.

increase of moisture content, while sphericity increased from 41.6 to 44.1%. Bulk density of fennel seed linearly decreased from 376.27 to 314.67  $\text{kg.m}^{-3}$  and true density increased from 818.29 to 894.63  $\text{kg.m}^{-3}$  with the increase moisture content. Porosity increased from 54 to 64.8%. The angle of repose increased from 36.33 to 48.66°. Static coefficient of friction was the most against plywood and iron and least on the glass surfaces.

## REFERENCES

- Altuntaş E, Özgöz E, Taşer ÖF (2005). Some physical properties of fenugreek (*Trigonella foenum-graceum* L.) seeds. *J. Food Eng.* 71: 37-43.
- Altuntaş E, Yıldız M (2007). Effect of moisture content on some physical properties of faba bean grain. *J. Food Eng.* 78: 174-183.
- Amin MN, Hossain MA, Roy KC (2004). Effect of moisture content on some physical properties of lentil seeds. *J. Food Eng.* 65: 83-87.
- Aviara NA, Gwandzang MI, Haque MA (1999). Physical properties of guna seeds. *J. Agric. Eng. Res.* 73(2): 105-111.
- Aydin C, Ögüt H, Konak M (2002). Some physical properties of Turkish Mahaleb. *Biosystem Engineering.* 82(2): 231-234.
- Baryeh EA (2002). Physical Properties of Millet. *J. Food Eng.* 51: 39-46.
- Baumler E, Cuniberti A, Nolasco SM, Riccobene IC (2006). Moisture-dependent physical and compression properties of safflower seed. *J. Food Eng.* 79: 134-140.
- Çarman K (1996). Some physical properties of lentil seeds. *J. Agric. Eng. Res.* 63(2): 87-92.
- Coşkun MB, Yalçın I, Özarslan C (2005). Physical properties of sweet corn seed (*Zea mays saccharata* Strut). *J. Food Eng.* 74: 523-528.
- Coşkun Y, Karababa E (2007). Some Physical Properties of Flaxseed. *J. Food Eng.* 78: 1067-1073.
- Deshpande SO, Bal S, Ojha TP (1993). Physical properties of soybean. *J. Agric. Eng. Res.* 56: 89-98.
- Dursun E, Dursun I (2005). Some physical properties of Cuper seed. *Biosyst. Eng.* 92(2): 237-245.
- Gupta RK, Das SK (1997). Physical properties of sunflower seeds. *J. Agric. Eng. Res.* 66(1): 1-8.
- [Http://www.herbsociety.org](http://www.herbsociety.org). Text ©1999, 2005 The Herb Society of America - 9019 Kirtland Chardon Road, Kirtland, OH 44094 (440) 256-0514 .
- Konak M, Çarman K, Aydın C (2002). Physical properties of chick pea seeds. *Biosyst. Eng.* 82(1): 73-78.
- Mohsenin NN (1970). *Physical Properties of Plant and Animal Materials*. Gordon and Breach Science Publishers, New York.
- Mohsenin NN (1986). *Physical Properties of Plant and Animal Materials*,

- second ed. Gordon and Breach Science Publishers, New York. Nimkar P.M and Chattopadhyay P.K., (2001). Some physical properties of green gram. J. Agric. Eng. Res., 80(2): 183-189.
- Paksoy M, Aydin C (2004). Some physical properties of edible squash (*Cucurbita pepo* L.) seeds. J. Food Eng., 65: 225-231.
- Razavi S, Milani E (2006). Some physical properties of the watermelon seeds. Afr. J. Agric. Res., 13: 65-69.
- Saçılık K, Öztürk R, Keskin R (2003). Some physical properties of hemp seed. Biosyst. Eng., 86(2): 191-198.
- Selvi KÇ, Pinar Y, Yeşiloğlu E (2006). Some physical properties of linseed. Biosyst. Eng., 95(4): 607-612.
- Suthar SH, Das SK (1996). Some physical properties of karingda [*Citrullus lanatus* (thumb) mansf] seeds. J. Agric. Eng. Res. 65(1): 15-22
- Tabatabeefar A (2003). Moisture-dependent physical properties of wheat. Int. Agrophysics. 17: 207-211.
- Tunde-Akintunde T.Y and Akintunde B.O., (2004). Some physical properties of sesame seed. Biosyst. Eng., 88(1): 127-129.