

Full Length Research Paper

Optimization of electrical production of a hybrid system (solar, diesel and storage) pilot using HOMER in Biret, Southern Coast of Mauritania

I. B. Ramdhane^{1,2*}, D. Ndiaye¹, M. M. Menou^{2,3}, A. K. Mahmoud², A. M. Yahya^{2,3} and A. Yahfdhou^{2,3}

¹Laboratory of Electronic, Computing, Telecommunication and Renewable Energies (LEITER), UGB, Saint-Louis, Senegal.

²Applied Research Laboratory for Renewable Energies (LRAER), University of Science, Technology and Medicine, Nouakchott, Mauritania.

³Laboratory of Semiconductor and Solar Energy (LASES), Faculty of Science and Technology, Cheikh Anta Diop University, Dakar, Senegal.

Received 27 April, 2017; Accepted 22 August, 2017

The purpose of this work is to study the optimization of an hybrid system of electricity production (solar-diesel with storage) of Biret (Mauritania) using the Hybrid Optimization Model for Electric Renewables (HOMER) software. Indeed, it shows that the context and behavior of the chosen system is optimal. HOMER is used to present simulations in the most economical way. It is important to note that the application of HOMER (using meteorological data obtained on the site) analyses the profitability or otherwise of the technologies used in Biret and proposes a hybrid system, taking into account the economic aspects of the project. From this perspective, simulations can be carried out to obtain the best configuration of the hybrid system used for electricity production in Biret. These simulations show the economic optimization of an electricity production using a hybrid system. To this end, a pilot installation, based on this concept, was carried out in Biret. It consists of a 61.44 kw solar field and a 40 kW generating set with 2950 Ah storage system. Optimization of the pilot unit was first studied using the solar-diesel system and secondly by operating the diesel coupled to the storage system. This led to the conclusion that a slight increase in sunshine will result in a decrease in the price of Kwh. On the other hand, that any increase in the price of diesel, while maintaining the constant sunshine will lead to an increase in the price of Kwh. This makes it possible to position this paper in terms of optimal management of the hybrid electricity production system, as a first step of popularizing the photovoltaic systems in the countries of Sahel.

Key words: Homer, hybrid system, optimization, solar radiation.

INTRODUCTION

According to the articles written in recent years, we note that projects on off-grid photovoltaic and wind systems are increasing in a notable way. In this process, Bernal and Dufo-Lopez (2009) and Vaughn et al. (2002),

showed that hybrid autonomous systems with renewable energies are generally more suitable than systems that have a single source of energy for the supply of electricity from off-grid systems. These types of systems



Figure 1. Village of Biret.
Source: Google Earth

demonstrate greater reliability than simple photovoltaic or wind power systems. Then, there is obviously a great interest on hybrid systems as shown in the works of Bernal and Dufo-Lopez (2009) and Stoyanov (2011). In this context, the objective sought through the introduction of hybrid systems in these areas is motivated by the search for saving fuel thanks to the sun or the wind compared to diesel and aims to maintain continuous power supply. Therefore, research in this field is oriented to offer a solution of independence vis-à-vis the rising prices of diesel. Indeed, from this perspective, many software help to optimize and test the hybrid system. More precisely, Chen et al. (2015) illustrated the results obtained from the HOMER (Hybrid Optimization Model for Electric Renewables) system using an algorithm. Diesel generator is used as the main power source in this research.

On the other hand, the presence of solar in these sites could favor photovoltaic systems rather than diesel, and imported fuel systems. Hence, the objective of this study is to optimize the coupling between photovoltaic and diesel production with a storage system for these areas of the South littoral using the HOMER software. Thus, the demonstration of several configurations using HOMER systems can optimize cost and generate sensitivity

results for most situations. Hence, HOMER allows the performance of sensitivity analyses and answers the following design questions:

1. Which technologies are most profitable?
2. What is the power generation of hybrid system components?
3. Which sensitivity analysis is used for the economic aspects of the project?
4. Are renewable energy sources like solar power available to supply the necessary energy for the Southern Coast of Mauritania?

The answer to these questions makes it possible to confirm or not the profitability of the use of a hybrid system for energy generation in Biret.

METHODOLOGY

Presentation of the site

The village of Biret (Figure 1) belongs to the Southern Coast of Mauritania. It has about 150 families. The overall economy of the village is based on fishing activities. Biret is located in the area which has a border with the city of Saint Louis of Senegal. Thus,

*Corresponding author. E-mail: smailr814.sr@gmail.com. Tel: 0022233078993.

Author(s) agree that this article remain permanently open access under the terms of the [Creative Commons Attribution License 4.0 International License](https://creativecommons.org/licenses/by/4.0/)

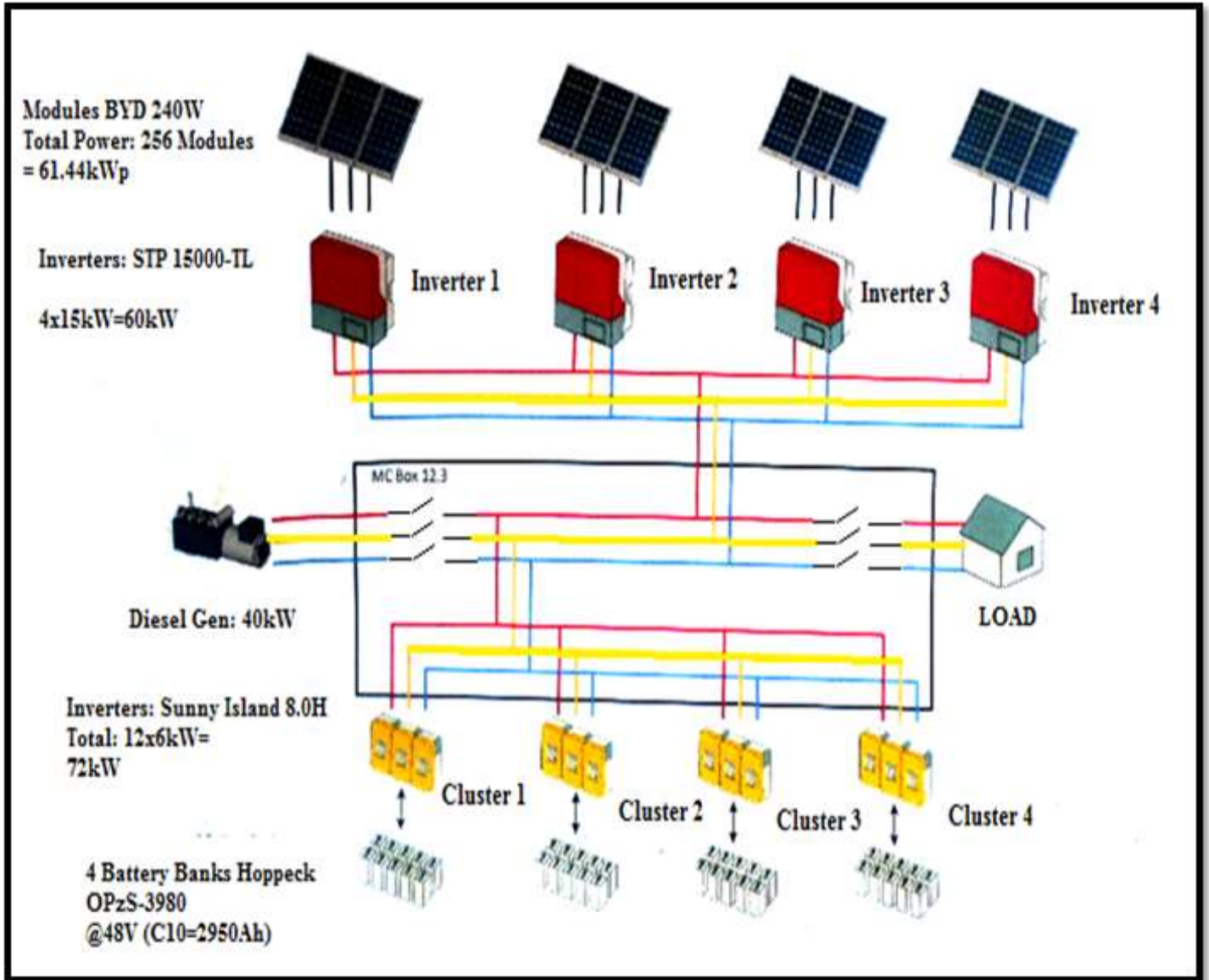

Figure 2. Summary of the Biret hybrid plant (real).
 Source: APAUS (Agency for the Promotion of Universal access to Services).

most of its economic and trade relations are with Senegal, especially for reasons of accessibility, while the road that leads to Rosso is longer.

The hybrid plant in Biret

The hybrid system is proposed for optimization to produce a quasi-autonomous one in its current configuration, which, in the future, may be connected to the Ndiago network (a locality some 20 km from Biret). The hybrid plant (Figure 2) of Biret is composed of:

1. A photovoltaic field: 256 Modules (Modules BYD 240W) of power 61.44 kWp,
2. A 40 KW diesel generator set,
3. A storage system of 96 battery nominal voltage of 48 V and

capacity of 2980 Ah (4 battery banks Hoppeck OPzS-3980 48 V (C10 = 2950 Ah)),

4. PV inverters power the grid (AC coupling) with electricity. There are four (3) three-element converters (inverters) which are coupled with a nominal power of 60 KW according to the configuration of inverters STP 15000-TL (Figure 2),

5. The Sunny Island is an inverter which controls the network (battery, source and load management): there are four (4) groups of inverters (each three inverters are in parallel and are powered by 4 banks with batteries of 48 V which are shown in Figure 2 in the form of a cluster). The cluster is presented as follows: 12 x 6 kW (Inverters, Sunny Island 8.0H).

The model of this hybrid system is presented by HOMER in Figure 3. It can be simulated by the introduction of many factors such as the cost of components, the availability of resources. Another major

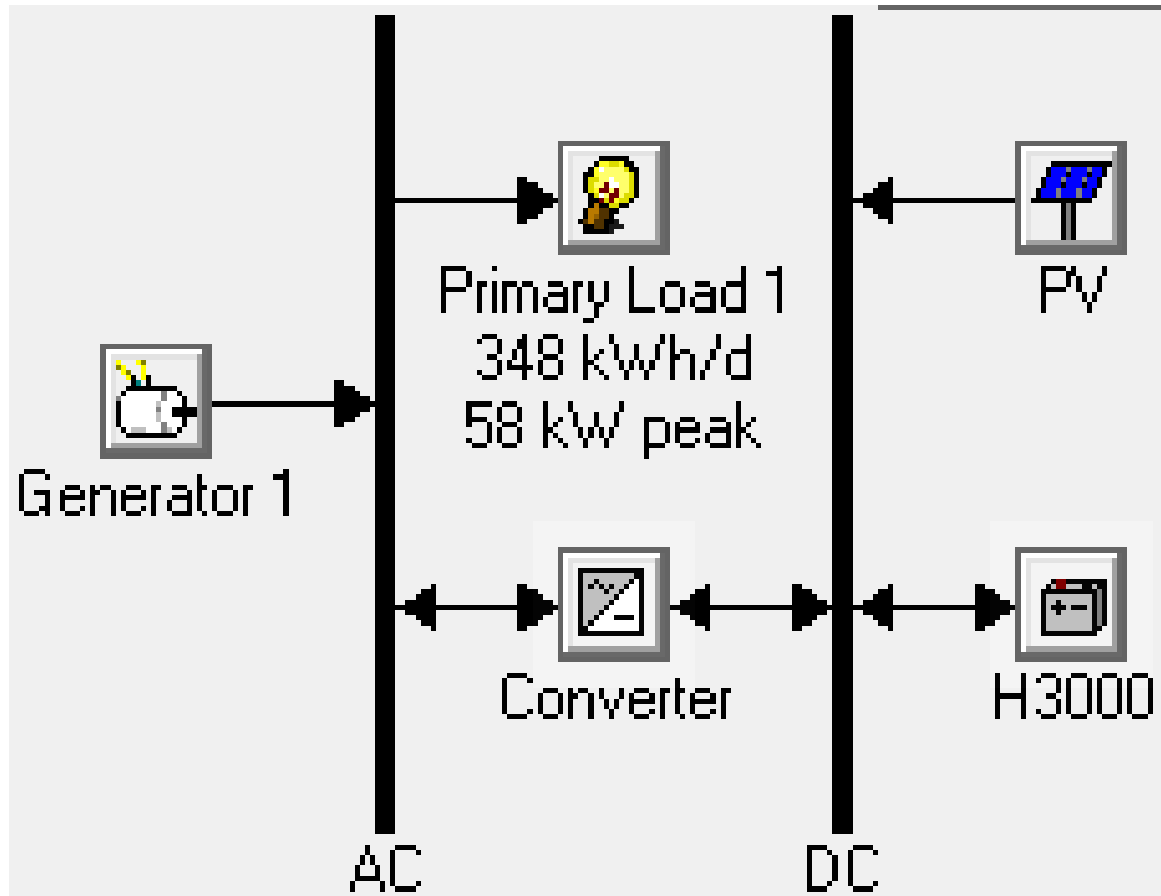

Figure 3. Hybrid system for Biret using HOMER simulation .
Source: Simulation by HOMER

factor in this digital implantation is related to the estimated lifetime of the project, which is generally estimated for 25 years (Adaramola et al., 2014). The calculations presented by the software take into account values such as interest capital, depreciation, operating costs, fuel costs. All its estimates are part of the proper functioning of the system studied.

On the HOMER environment, each element of our installation was defined on the basis of all the characteristics and data that are recovered on site. We give the annual evolution of the main climatic characteristics of the chosen site.

Solar irradiation of the site

Figure 4a shows a simple description of the evolution of solar radiation (KW/m^2) throughout the year. On the other hand, Figure 4b shows DMAP of the site irradiation. This type of graph shows one year of hourly data. Every hour of the year is presented by a color that simulates accurate information data value. This presentation makes it possible to see more clearly the information useful for an easy and concrete interpretation.

In this regard, the sunshine periods (Figure 4a) below $1 \text{ KW}/\text{m}^2$ are highly expressed in the months of late September, October, November, December, January and February. There are periods that are pointed at the value below $0.6 \text{ KW}/\text{m}^2$ (end of January, beginning of September, beginning of November and December). Figure 4a gives the same values in the form of more expressed

zones; for example red is used for the values of more $1 \text{ KW}/\text{m}^2$, for the months of March, April, June, July, August and September and green color is below $0.6 \text{ KW}/\text{m}^2$, on both sides for the months of the following year.

Load profile

The profile of the load developed and projected during the design for the locality of Biret is AC (alternating current). It is operated continuously throughout the year with an average calculated for 348 kWh/day , and a power of 58 kW calculated to cover the maximum demand of the Biret system. On the other hand, the daily profile of the load which is given by simulation through HOMER according to the data collected on the actual site, as well as their annual evolution is proposed in Figures 5 and 6. HOMER simulation of the different loads in a day gives a peak power of 20 kW and a maximum of 35 kW between 8 to 11 h. The distribution of the charge in Figure 5 is distributed between the illumination on either sides of the demand for water pumping which is located at the peak moments of the demand between 9 - 11 am.

RESULTS AND DISCUSSION

The results obtained from the data and simulations are

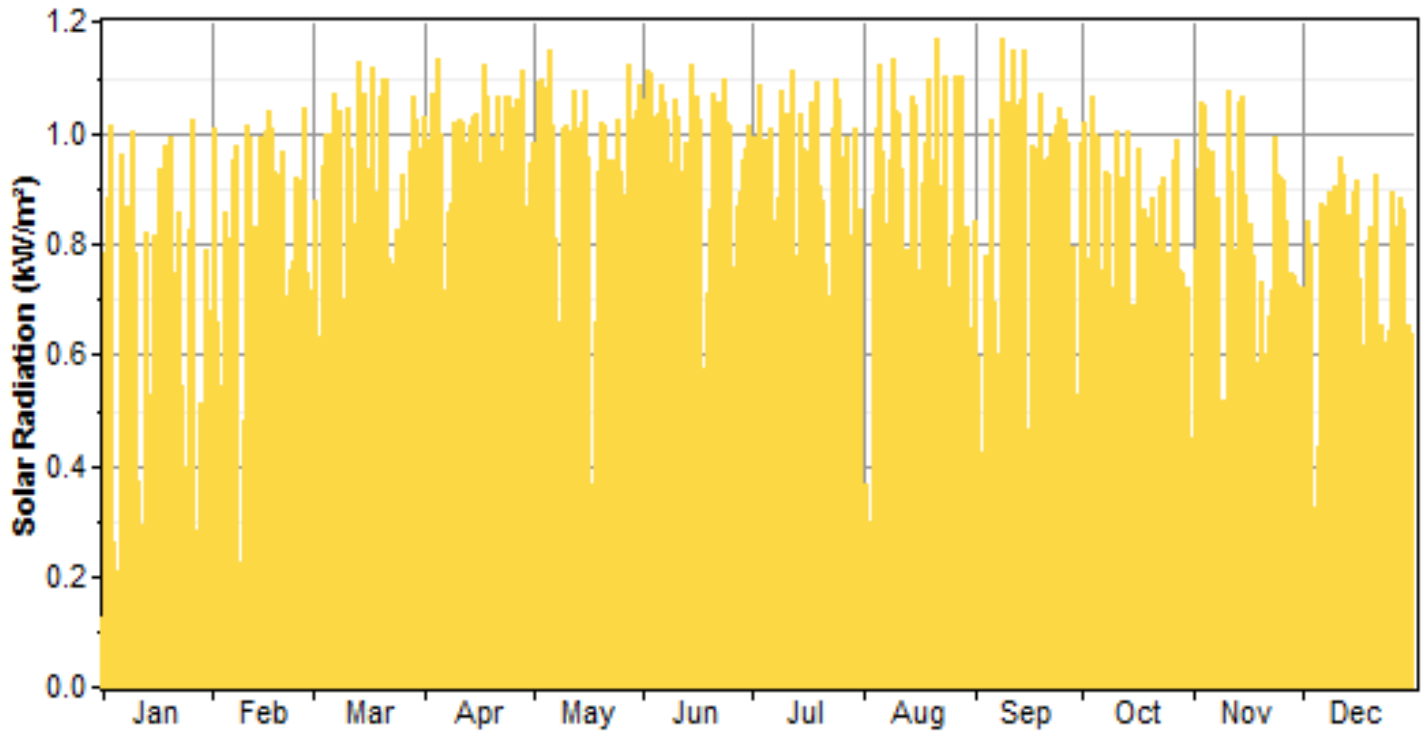

Figure 4a. Annual evolution of solar irradianations.
Source: Simulation by HOMER

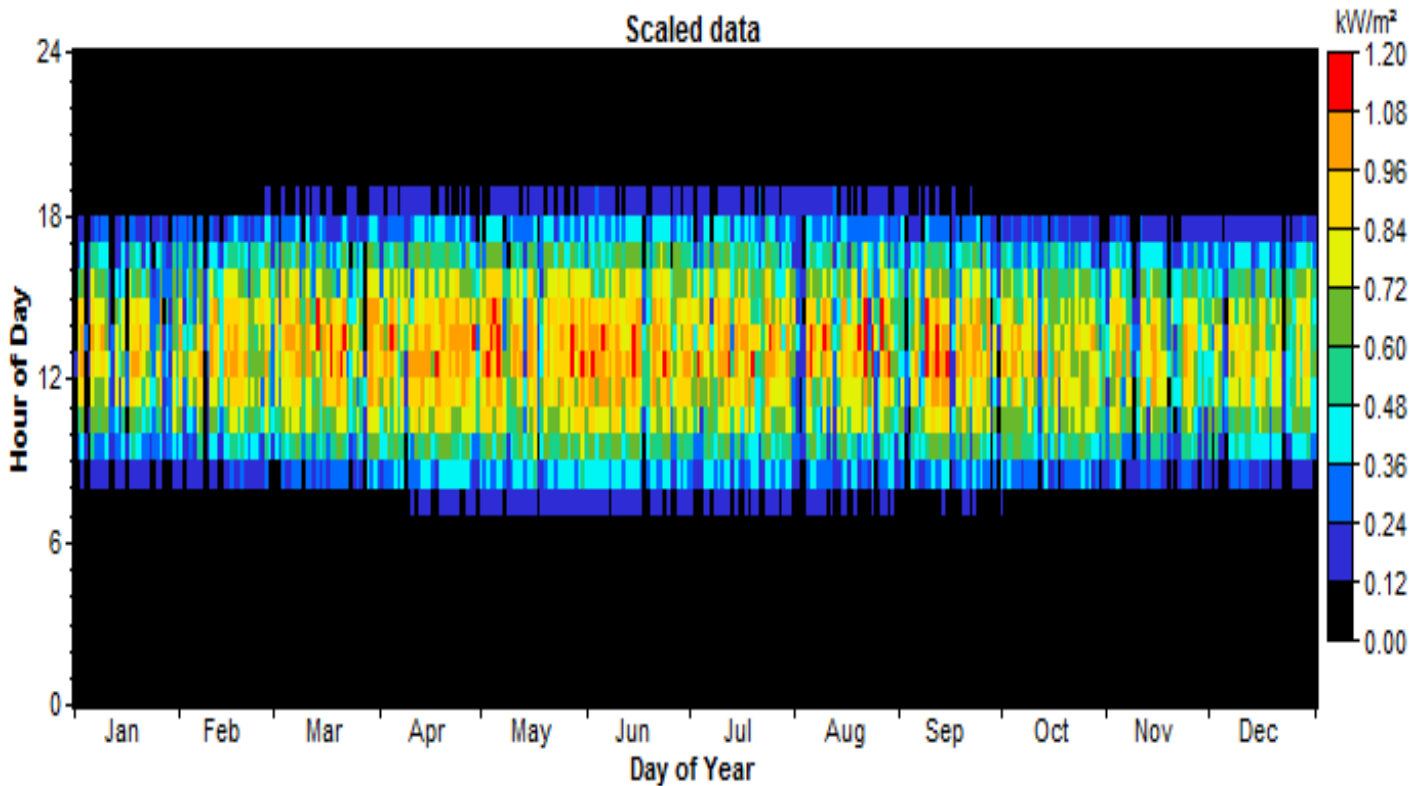

Figure 4b. DMAP (DMAP: data Map in year).

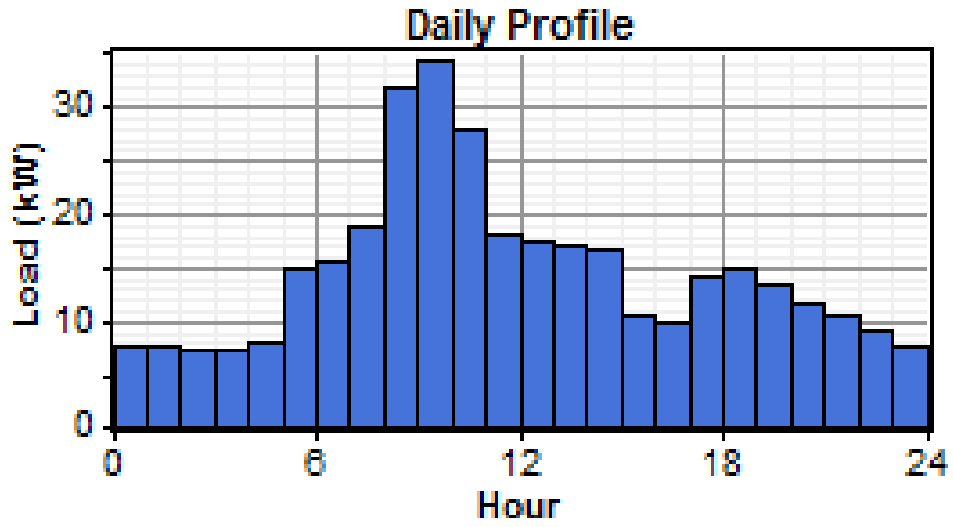

Figure 5. Daily load profile.

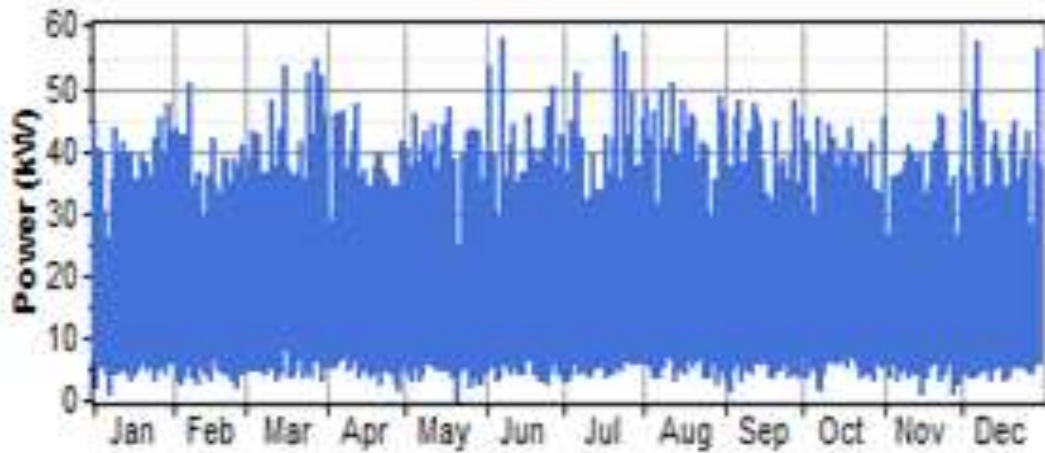

Figure 6a. Annual evolution of the load.

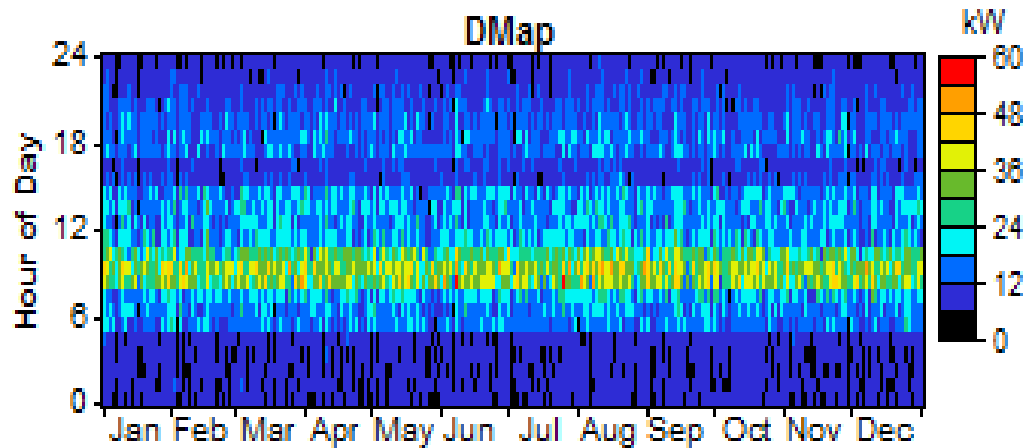

Figure 6b. DMAP. (data Map in year)

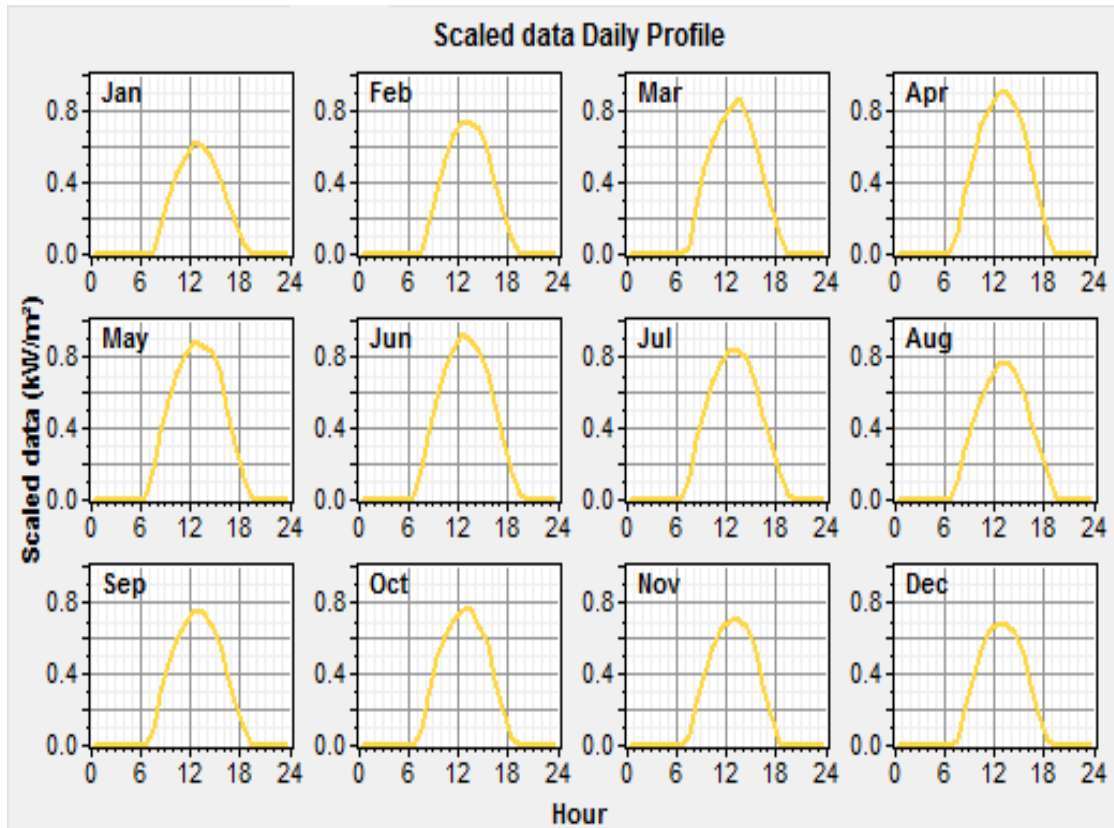

Figure 7. Annual solar irradiation profile.
Source: Simulation by HOMER.

illustrated in Figures 7 to 11, Plate 1 to 2 and Tables 1 to 2, since it is possible to enter many different configurations in the same type of system. In this context, we are studying the behavior of the same system. The results show that HOMER presents simulations that are most economical for each category of simulated system (Mahmoud and Ibrik, 2006), based on its type. Optimization of the simulated system is thus important within this economic option. This is reflected in an even more thorough study of the economic variant in order to show its advantages and limitations, which is better than other configurations (Kaabeche and Ibtouen, 2014; Li et al., 2013; Kumar et al., 2011). Similarly, this research provides an understanding of the physical phenomenon, especially those related to the sensitivity of the system.

Profile of sunshine (KW/m²) and demand (KW)

The annual profiles of solar irradiation (Figure 7) and charge (Figure 8) vary monthly in a similar manner. Indeed, to better understand Figures 7 and 8, it is important to consider the behavior in each month.

For the annual profile of solar irradiation (Figure 7), the following are recorded:

1. The days of the month with values greater than 0.8 kW/m²/day: March: max 0.82 kW/m²/day; April: max 0.84 kW/m²/day; May: max 0.82 kW/m²/day; June: max 0.86 kW/m²/day; July: max 0.80 kW/m²/day.
2. Days of the month with values less than 0.8 kW/m²/day: August: max 0.79 kW/m²/day; September: max 0.78 kW/m²/day; October: max 0.79 kW/m²/day; November: max 0.78 kW/m²/day; December: max 0.76 kW/m²/day; January max: 0.60 kW/m²/day; February: max 0.78 kW/m²/day.

The Biret site has a large solar potential which oscillates between a minimum value of 0.60 kW/m²/days in January and a maximum value of 0.86 kW/m²/days in June.

Analysis of the annual load profile

The analysis of the month of January in Figure 8 which records the least amount of sunshine (minimum value of 0.60 kW/m² given in Figure 7) in this area of the Sahel makes it easier to understand the events of the load profile and those that will repeat themselves in the Biret locality in the other months that follow, for the following reasons:

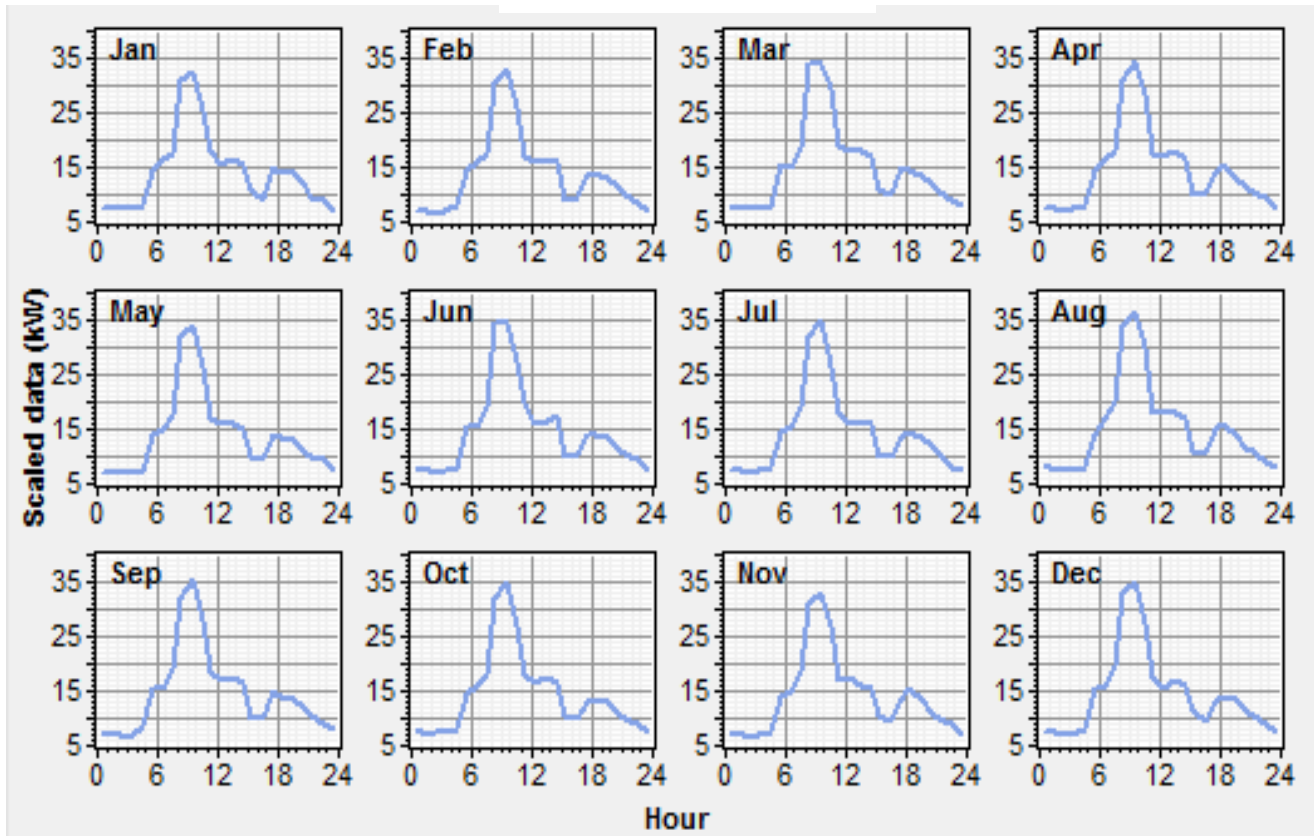

Figure 8. Annual load profile.
Source: Simulation by HOMER

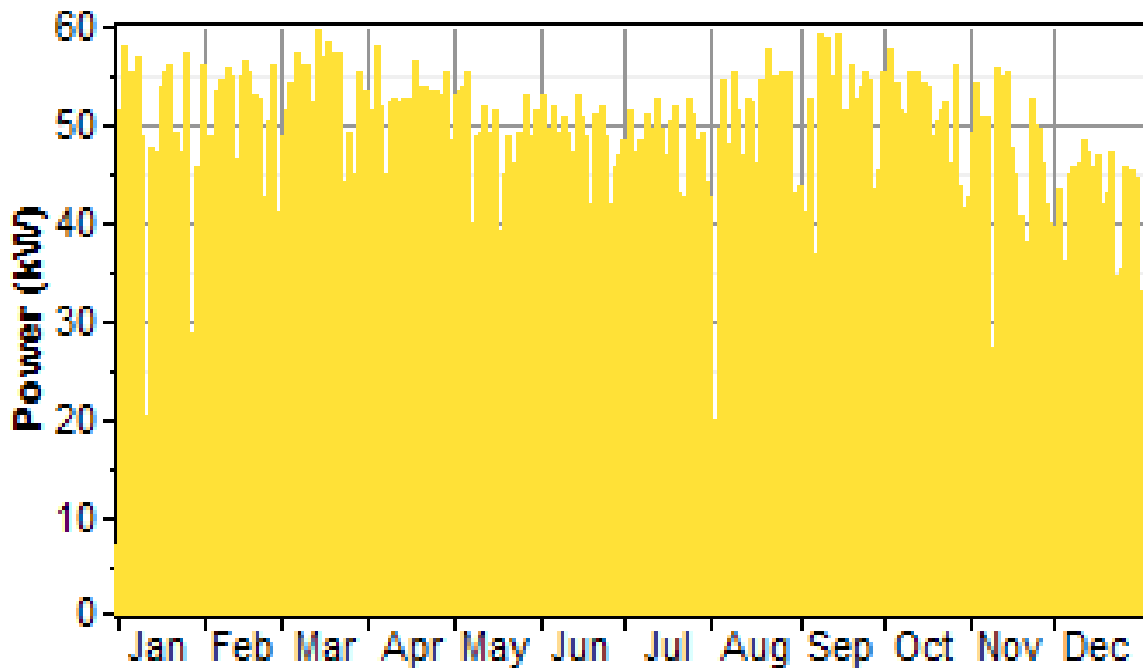

Figure 9. Annual distribution of the power produced by the PV generator.
Source: Simulation by HOMER

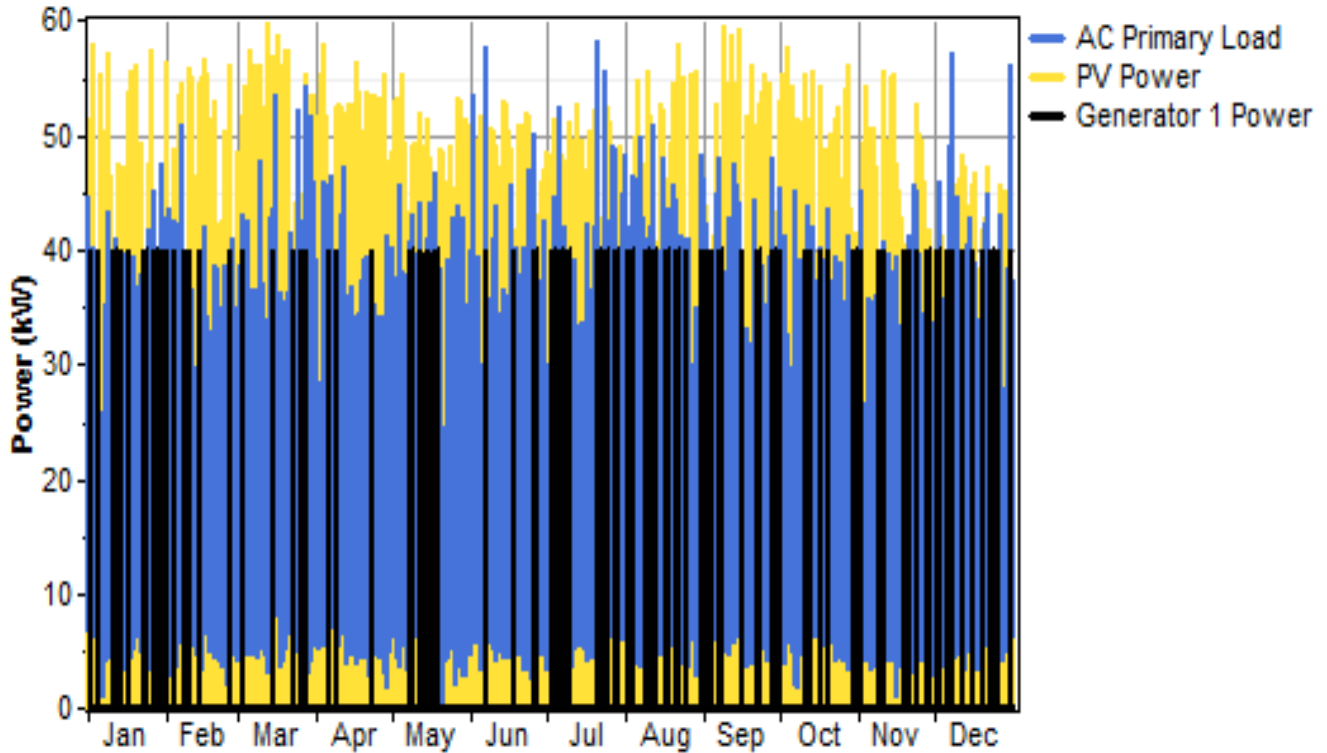

Figure 10. Distribution of the load and power produced by each system.







Global Solar (kWh/m ² /d):	5.78 kWh/m ² /d
Diesel Price (\$/L):	1.09 \$/L
System type	Total net present cost
PV/Label/Battery	\$ 836,113 
Label/Battery	\$ 1,926,424 

Figure 11. Optimization ranking by size of investments.
Source: Simulation by HOMER

1. At 0.6 h, the load is at its lowest, following a minimal activity within the locality and it is about 5 kW.
2. Between 6 to 12 h, the demand in this part passes through the maximum peak of the load between 30 and 35 kW close to the middle of the peak and more precisely between 7 to 11 h, on the site. This phenomenon of peak during this period is explained by the pumping of the water which always manifests around this interval. Water

- pumping occurs almost periodically in this interval to fill the water tank during the peak of sunshine (0.60 kW/m² given in Figure 7 for this month). Thus, the pumping causes a peak of the demand recorded on the curve of the load profile to appear (Figure 8).
3. Between 6 and 12 h, the simulations for the different months in Figure 8 shows each time sunshine is located close to the time interval of 6 to 12 h for each day of the

Plate 1. Optimum result for different configurations.

Sensitivity Results		Optimization Results											
Sensitivity variables													
Global Solar (kWh/m ² /d)		5.81		Diesel Price (\$/L)		1.11							
Double click on a system below for simulation results.													
		PV (kW)	Label (kW)	H3000	Conv. (kW)	Initial Capital	Operating Cost (\$/yr)	Total NPC	COE (\$/kWh)	Ren. Frac.	Diesel (L)	Label (hrs)	
													
		61.44	40	96	60	\$ 431,744	31,168	\$ 830,182	0.511	0.81	9,018	709	
			40	96	60	\$ 188,344	136,940	\$ 1,938,893	1.194	0.00	47,122	3,570	

month. It is precisely based on the shape of the curve of the sunshine (Figure 7) of the same months that the electric charges seek to follow and copy this zone of the Sahel.

4. Between 6 and 12 h, the simulations show the pumping time that is programmed to fill the water tower for a duration of 4 h in a systematic way, for each day.

5. Between 12 and 18 h, the demand in this zone falls when the whole population is in the fields.

6. Between 18 and 24 h, the demand in this zone drops which is initiated in the previous step until it regains the value of 5 kW.

Simulation of photovoltaic production system and loads

Photovoltaic production

Figure 9 (photovoltaic system) shows an average annual power generation of 45 kW and sometimes, values can reach 60 kW. This power is greater than that recorded at the peak of the load profile (Figure 8) during the day in the pumping operation interval which produces 35 kW. This indicates that the site provides favorable conditions to store energy in the batteries (storage system). This stored energy in these periods of surplus production will be used for night loads, when there is no sunlight.

Distribution of charge and production power for each of the systems

In the HOMER simulation results window, several technical and economic details are proposed for each system configuration (Agarwal and Kumar, 2013; Protopogopoulos et al., 1998; Muselli et al., 1999).

Using the HOMER simulation software, hybrid system are configured from the optimal combination of the building elements of the system. It is presented according































































to net present value (NPC) and various constraints found in the system definition. The case of Biret deals with simulation of a hybrid system made up of electric power generation, photovoltaic and diesel systems. With the presence of batteries and converters, the system is an autonomous network as presented using HOMER.

Plate 1 shows the demand of Biret locality and the different configurations of hybrid systems in an off-grid situation. The various possible combinations of these systems have been analyzed using HOMER system. Plate 1 gives the most economical (photovoltaic, diesel and storage) and least economical technology (diesel and storage) according to price per kWh.

Thus, for photovoltaic, diesel and storage, the best system would be the technology that integrates the different components (photovoltaic, diesel and battery storage through a converter). Thus, HOMER proposes the second variant of the hybrid system comprising diesel and battery storage via converter system.

In reality, HOMER proposes diesel,-without storage-without converter system. In this context, it should be noted that the diesel system (40 kW) alone covers just demand which oscillates around 35 kW at peak times (Figures 5 and 8) (annual load profile). The peak recorded during the day is more precisely between 7 to 11 h. Thus, HOMER considers that any variation in load above 35 kW will lead to load shedding. For uninterrupted supply, HOMER proposes a battery-converter couple system. Thus, during hours when demand is very low (between 5 and 35 kW), the generator (with an adequate power of 40 kW) charges the batteries. Thus, the power generated by the batteries enables them to intervene during high demands which, in this case is during the start-up of pumps which actuates pumping. It should also be noted that HOMER addresses this issue as there was the possibility of proposing a group that generates (power) greater than 40 kW. According to the configurations proposed by HOMER software for Biret, it is important to note that the proposed diesel system, after several years, will become less relevant in power

Plate 2. Simulation result for sensitivity analysis.

Solar (kWh/m ² /d)	Diesel (\$/L)				PV (kW)	Label (kW)	H3000	Conv. (kW)	Initial Capital	Operating Cost (\$/yr)	Total NPC	COE (\$/kWh)	Ren. Frac.	Diesel (L)	Label (hrs)
5.790	1.050				61.44	40	96	60	\$ 431,744	31,133	\$ 829,724	0.511	0.80	9,178	722
5.790	1.070				61.44	40	96	60	\$ 431,744	31,314	\$ 832,039	0.512	0.80	9,178	722
5.790	1.090				61.44	40	96	60	\$ 431,744	31,497	\$ 834,385	0.514	0.80	9,178	722
5.790	1.110				61.44	40	96	60	\$ 431,744	31,680	\$ 836,727	0.515	0.80	9,176	722
5.770	1.050				61.44	40	96	60	\$ 431,744	31,616	\$ 835,905	0.515	0.80	9,361	735
5.770	1.070				61.44	40	96	60	\$ 431,744	31,834	\$ 838,694	0.517	0.80	9,368	736
5.770	1.090				61.44	40	96	60	\$ 431,744	32,022	\$ 841,089	0.518	0.80	9,368	736
5.770	1.110				61.44	40	96	60	\$ 431,744	32,209	\$ 843,484	0.519	0.80	9,368	736
5.800	1.050				61.44	40	96	60	\$ 431,744	30,914	\$ 826,925	0.509	0.80	9,127	716
5.800	1.070				61.44	40	96	60	\$ 431,744	31,098	\$ 829,283	0.511	0.80	9,127	716
5.800	1.090				61.44	40	96	60	\$ 431,744	31,281	\$ 831,617	0.512	0.80	9,127	716
5.800	1.110				61.44	40	96	60	\$ 431,744	31,463	\$ 833,950	0.514	0.80	9,127	716
5.809	1.050				61.44	40	96	60	\$ 431,744	30,672	\$ 823,831	0.507	0.81	9,060	710
5.809	1.070				61.44	40	96	60	\$ 431,744	30,853	\$ 826,147	0.509	0.81	9,060	710
5.809	1.090				61.44	40	96	60	\$ 431,744	31,060	\$ 828,791	0.510	0.81	9,062	711
5.809	1.110				61.44	40	96	60	\$ 431,744	31,241	\$ 831,108	0.512	0.81	9,062	711
5.810	1.050				61.44	40	96	60	\$ 431,744	30,602	\$ 822,938	0.507	0.81	9,016	708
5.810	1.070				61.44	40	96	60	\$ 431,744	30,782	\$ 825,243	0.508	0.81	9,016	708
5.810	1.090				61.44	40	96	60	\$ 431,744	30,988	\$ 827,876	0.510	0.81	9,018	709
5.810	1.110				61.44	40	96	60	\$ 431,744	31,168	\$ 830,182	0.511	0.81	9,018	709

generation compared to the photovoltaic system.

Sensitivity analysis for economic aspects of the project

In order to better show the sensitivity analysis of the economic aspects of the project, simulation analysis must be carried out for the following five constant daily average sunshine values: 5.790, 5.770, 5.800, 5.809 and 5.7810 kWh/m²/day. In the same way, it will be necessary to proceed to simulation with respect to the economic aspects. In this logic, sensitivity and economic aspects are closely related to the values of sunshine as a function of the price of diesel. From this point of view, in order to show the sensitivity analysis of the system as a function of the power values or the size of the configuration, it is important to examine changes in diesel prices over 10 years with the current price in Mauritania. It should also be noted that in the Sahel sub-region, economic aspects are linked to the price of diesel which is volatile. This price is given by the Mauritanian Society of Refining Industries (SOMIR). On the basis of these estimates, the price of diesel in Mauritania is close to 1.05 \$/L. By way of comparison, the world average diesel price for this period is 0.92 \$/L. Thus the price reference for Mauritania taken into account in this study is 1.05 \$/L. It should be noted that over the past ten years, there have been few changes in diesel prices in Mauritania. Thus, it is possible to identify the economic sensitivity using HOMER software on changing diesel prices and given sunshine values and thus determine the choice of configurations. Plate 2 presents the result of the simulations with the costs of diesel per liter. Plate 2 presents the sensitivity analysis for hybrid electrical

production. Tables 1 and 2 highlight the influence of the price of diesel and that of sunlight. It is thus possible to conclude that a small increase in sunlight will result in a decrease in the price of kWh. This is why the characteristics of the site, especially its sunshine, play an important role in the price of kWh. Therefore, it is possible to say that meteorological characteristics are of high importance for photovoltaic systems. In conclusion, any increase or decrease in sunlight on the site will highlight or cause the classification of the photovoltaic system and storage versus diesel within a hybrid system. Thus, in this component, good sunshine, like in Biret site, favors power generation using photovoltaic systems compared to diesel use. In the same vein, it is important to note that a minimal increase in the price of diesel (1.05, 1.07, 1.09 and 1.11 \$/L) with the same amount of sunlight (for example, 5.770 kWh/m²/day) will result in an increase in kWh price from \$ 0.515 to 0.518 \$/kWh, with a difference between the two values of 0.003 \$/kWh. Thus any increase in the price of diesel, while maintaining constant sunshine will lead to an increase in the price of kWh. Similarly, any increase in the price of diesel will enhance the classification of the configuration of the photovoltaic system and its storage compared to diesel alone or with the storage and converter system. Overall, the electrical system to consider for this site is the photovoltaic system used for storage and minimal diesel system (emergency).

In conclusion, countries in the Sahel will be led to develop more storage-based photovoltaic systems that have less price implication compared to diesel (since sunshine is important). Increases in the price of diesel do not allow the latter to be the solution for generating electricity. It should also be noted that the price of

Table 1. Sensitivity analysis (increase in sunshine).

Diesel price (\$/L)	Solar radiation : KWh/m ² /d	5.770	5.790	5.800	5.809	5.810
		Price of KWh (\$)				
1.05		0.515	0.511	0.509	0.507	0.507
1.07		0.517	0.512	0.511	0.509	0.508
1.09		0.518	0.514	0.512	0.510	0.510
1.11		0.519	0.515	0.514	0.512	0.511

Table 2. Result of sensitivity (increase in diesel price).

Solar radiation (KWh/m ² /d)	Diesel price (\$/L)	1.05	1.07	1.09	1.11
		Price of KWh (\$)			
5.770		0.515	0.517	0.518	0.518
5.790		0.511	0.512	0.514	0.515
5.800		0.509	0.511	0.512	0.514
5.809		0.507	0.509	0.510	0.512
5.810		0.507	0.508	0.510	0.511

photovoltaic panels will continue to decrease to further strengthen the photovoltaic system with storage. Indeed, HOMER simulates all feasible configurations of hybrid systems capable of operating perfectly in Biret with the provision of sufficient electrical energy to the load profile. The classification of optimization according to the comments that have already been expressed makes it possible to opine that the solar source is a very important factor in the supply of electrical energy necessary for Biret's electric needs. Evaluating economic aspects highlights the adequate size of the photovoltaic system and takes into account the size of the storage system in relation to the size of diesel system depending on investments for the project.

Conclusion

The results of this study shows that the photovoltaic cells coupled to a storage system technology is a better choice for electricity production in Biret. Using HOMER simulation can provide the necessary energy in the South littoral regions of Mauritania. Sensitivity analysis of HOMER showed that any change in load above the mean value of 35 kW can disrupt continuous electricity service in the locality. This is why HOMER proposes a reinforcement of the hybrid system in Biret by coupling with diesel and a storage system, while stressing that the storage system makes this variant expensive. It should be noted that for continuous electricity supply, HOMER proposed a system of coupling with batteries. In this option, the generator can charge the batteries for hours when the demand is very low (value between 5 and 35 kW) and once the batteries are charged, they can

become an alternative source of electrical production at times of high demand such as during the startup of water pumps.

Finally, it must be concluded that in Sahelian countries, photovoltaic systems with storage are economically better than diesel. Similarly, it should be noted that increases in diesel price do not allow electricity generation in isolated sites. The price of photovoltaic panels will continue to decline to reinforce the choice of photovoltaic solution with storage in the context of electricity production in the Sahel. Ultimately, this work allows extension for a wider use of photovoltaic systems with a diesel option in countries of the Sahel.

CONFLICT OF INTERESTS

The authors have not declared any conflict of interests.

REFERENCES

- Adaramola MS, Paul SS, Oyewola OM (2014). Assessment of decentralized hybrid PV solar-diesel power system for applications in Northern part of Nigeria. *Energy Sustain. Dev.* 19:72-82.
- Agarwal N, Kumar A (2013). Optimization of grid independent hybrid PV–diesel–battery system for power generation in remote villages of Uttar Pradesh, India. *Energy Sustain. Dev.* 17(3):210-219.
- Chen L, Li Y, Xiao J, Wei X (2015). Optimal configuration for distributed generations in micro-grid system considering diesel as the main control source. *J. Energy Power Eng.* 9:493-499.
- Kumar D, Bibhuti L, Dash B (2011). Optimization of PV/Wind/Micro-Hydro/Diesel Hybrid Power System in HOMER for the Study Area. *Int. J. Electrical Eng. Informatics* 3(3).
- Kaabeche A, Ibtouen R (2014). Techno-Economic Optimization of Hybrid Photovoltaic/Wind/Diesel/Battery Generation in a Stand-Alone Power System. *Solar Energy* 103:171-182.

- Bemal-Agus L, Dufo-Lapez R (2009). Simulation and optimization of standalone hybrid renewable energy systems. *Renew. Sustain. Energy Rev.* 13:2111- 2118.
- Li C, Ge X, Zheng Y, Xu C, Ren Y, Song C, Yang C (2013). Techno-economic feasibility study of autonomous hybrid wind/PV/battery power system for a household in Urumqi, China. *Energy.* 55:263-272.
- Mahmoud MM, Ibrik IH (2006). Techno-economic feasibility of energy supply of remote villages in Palestine by PV-systems, diesel generators and electric grid. *Renew. Sustain. Energy Rev.* 10(2):128e38.
- Muselli MN, Notton G, Louche A (1999). Design of hybrid-photovoltaic power generator, with optimization of energy management. *Solar Energy* 65(3):143-157.
- Protogeropoulos C, Brinkworth BJ, Marshall RH (1998). Sizing and techno-economical optimization for hybrid solar photovoltaic/wind power systems with battery storage. *Int. J. Energy Res.* 21(6):465-479.
- Stoyanov L (2011). Etude de différentes structures de systèmes hybrides à sources d'énergie renouvelables (Doctoral dissertation, Université Pascal Paoli).
- Vaughn CN, Foster R, Clark N, Raubenheimer D (2002). Wind hybrid systems technology characterization. West Texas AM University–AEI, New Mexico State University–SWTDI, USDA–ARS Bushland, Vista University, May 2002.