

*Full Length Research Paper*

# Numerical and experimental studies on the effect of loading angle on the validity of flattened Brazilian disc test

Pourya Khavari<sup>1\*</sup> and Mehrnoosh Heidari<sup>2</sup>

<sup>1</sup>Mining Exploitation Engineering, School of Mining Engineering, Faculty of Engineering, University of Tehran, Tehran, Iran.

<sup>2</sup>Rock Mechanics Engineering, School of Mining Engineering, Faculty of Engineering, University of Tehran, Tehran, Iran.

Received 26 December, 2015; Accepted 24 May, 2016

**In this study, effect of loading angle on location of crack initiation in flattened Brazilian disc (FBD) specimens was studied by both numerical and experimental methods. FBD tests were conducted on disc samples with various loading angles and tests were simulated by finite element method (FEM). The results showed that probability of crack initiation at flattened ends of samples where jaws and sample are connected should be considered along with central crack initiation which is a usual prerequisite to have a valid FBD test. In addition, experimental analysis was performed on FBD samples which is rarely observed in literature. Moreover, the loading angle of 30° was determined as an appropriate angle for FBD test that guarantees the occurrence of central crack and avoids crack initiation at flattened ends of samples.**

**Key words:** Fracture toughness, FBD method, loading angle, central crack, experimental method, numerical method.

## INTRODUCTION

Rock fracture mechanics is a general approach for solving many problems in the field of earth sciences such as geological engineering, mining engineering and civil engineering. Many rock engineering problems such as rock cutting can be solved by fracture analysis (Guo et al., 1993). Indeed, it is common for ageing infrastructures which have experiences of cracking such as dams, bridges, and buildings (Chowdhury et al., 2013). Measuring crack toughness is a key to analyze fracturing in materials (Guo et al., 1993). According to the types of

crack propagation through specimen, there are three major crack propagation modes in a fracture process, including: Mode I (tensional), Mode II (shearing), and Mode III (tearing) (Roylance, 2001). Mode I fracture toughness is the most important mode in brittle materials like rock since this mode commonly lead to failure in brittle materials (Alkilicgil, 2010). Different methods with different geometries have been developed for measuring Mode I fracture toughness, including short rod (SR) test (Barker, 1978), cracked straight through Brazilian disc

\*Corresponding author. E-mail: pouryakhavari@ut.ac.ir. Tel: +989356027952.

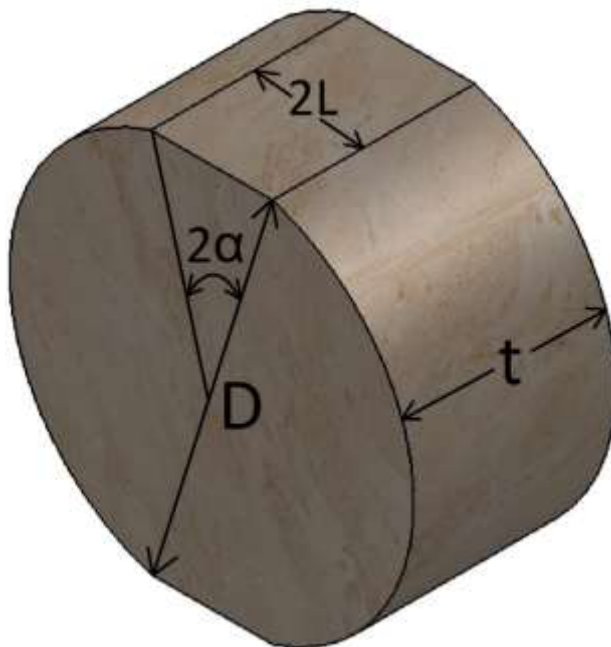

**Figure 1.** Flattened Brazilian disc geometry (Wang and Xing, 1999).

(CSTBD) test (Awaji and Sato, 1978), diametric compression (DC) test (Szendi-Horvath, 1980), cracked chevron notched Brazilian disc (CCNBD) test (Sheity et al., 1985; Dai et al., 2014), modified ring (MR) test (Thiercelin and Roegiers, 1986), Brazilian disc (BD) test (Ayatollahi and Aliha, 2008; Guo et al., 1993), flattened Brazilian disc (FBD) test (Wang and Xing, 1999), notched semi-circular bend (NSCB) test (Chong and Kuruppu, 1984), chevron bend (CB) test (Ouchterlony, 1988), straight edge cracked round bar bend (SECRBB) test (Ouchterlony, 1981), radial cracked ring (RCR) test (Chen et al., 2008), edge crack triangular (ECT) test (Aliha et al., 2013), edge notched disk (END) test (Donovan et al., 2004). Among the mentioned methods, short rod (SR) method, cracked chevron notched Brazilian disc (CCNBD) method and chevron bend (CB) method are methods suggested by ISRM (Khavari, 2015).

In general, the aforementioned methods could be classified according to their loading type into three main groups, including: A) Direct tension, B) compression, and C) bending (Alkilicgil, 2010). Compressive loading in fracture testing is more convenient for rocks. Brazilian type specimens with or without notches or inner holes can be loaded with compression at specimen ends to generate a tensile fracture formation and crack propagation at the center of discs. Brazilian type specimens can be attractive due to its simplicity of specimen preparation and loading configuration (Dai et al., 2014; Guo et al., 1993).

Among compressive tests, flattened Brazilian disc (FBD)

test is one of the most convenient method for determining fracture toughness of rocks and rock like specimens (Keles and Tutluoglu; 2011). However, the validity of FBD test depends on the location of crack initiation, and location of crack initiation is a function of loading angle ( $2\alpha$ ) (Figure 1) (Wang and Xing, 1999). Wang and Xing (1999) found the critical loading angle (loading angle that guarantees crack initiation from center of disc) to be greater than  $19.5^\circ$ . This angle was found to be equal to  $20^\circ$  by Wang and Wu (2004) and Wang et al. (2004), and  $15^\circ$  by Kaklis et al. (2005).

In this study, FBD method was evaluated by investigating the effect of loading angle on location of crack initiation. In this respect, we considered crack initiation on central zone of specimens and at flattened ends of the samples where jaws and specimens connected. Investigation of probability of crack initiation from the flattened ends of samples was rarely observed in literature. To this end, FBD tests with various loading angles were performed under displacement control machine which applied displacement to the specimen. Besides, related numerical models by finite element method (FEM) were performed to assess dimensionless stress and plastic strain distribution in FBD samples.

#### **FBD method and importance of fracture initiation location**

FBD method is the most convenient method among other methods in terms of specimen preparation, loading type

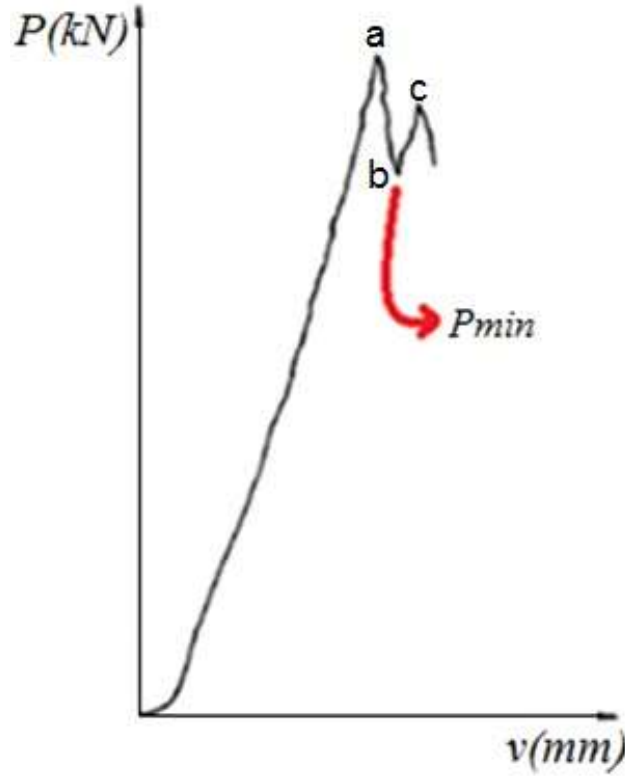

**Figure 2.** Typical load-vertical displacement graph of a valid FBD test (Keles and Tutluoglu, 2011).

and testing procedures (Keles and Tutluoglu, 2011). FBD specimen and related geometries are illustrated in Figure 1. In this Figure,  $D$ ,  $t$ ,  $2\alpha$  and  $2L$  are specimen diameter, specimen thickness, loading angle and flattened end width, respectively. Loading ends of disc is flattened to avoid concentrated loads and infinite stress concentrations around loading ends. In a valid test, crack should initiates from the center of disc and propagates toward loaded flattened ends of sample. According to Figure 2, load increases up to point (a) which crack initiates. During unstable crack propagation (ab), load decreases to point (b). Load in this point is equal to the minimum local load ( $P_{min}$ ) which is used in fracture toughness calculation by FBD method formula (Equation 1). When crack growth becomes stable, load starts to increase (bc). Point (c) is the point at which specimen fails (Keles and Tutluoglu; 2011).  $K_{Ic}$  is computed from the equation below (Wang and Xing 1999):

$$K_{Ic} = \frac{P_{min}}{\sqrt{R \times t}} \phi_{max} \quad (1)$$

Which  $K_{Ic}$  is mode I fracture toughness,  $P_{min}$  is minimum local load,  $R$  is specimen radius and  $t$  is specimen thickness. Dimensionless stress intensity factor ( $\phi$ ) for

flattened Brazilian disc with the loading angle of can be  $30^\circ$  ( $2\alpha \geq 30^\circ$ ) defined by (Wang and Wu, 2004):

$$\phi = K_I \frac{\sqrt{R \times t}}{P} = -33.9811 \left(\frac{a}{R}\right)^7 - 128.5613 \left(\frac{a}{R}\right)^6 + 189.8983 \left(\frac{a}{R}\right)^5 - 146.3809 \left(\frac{a}{R}\right)^4 + 64.0804 \left(\frac{a}{R}\right)^3 - 15.7996 \left(\frac{a}{R}\right)^2 + 2.7115 \left(\frac{a}{R}\right) \quad (2)$$

Where  $K_I$  is mode I stress intensity factor,  $P$  is applied compressive load and  $a$  is half of the crack length.  $\phi_{max}$  could be determined by numerical modeling (Wang and Wu, 2004).

The key factor,  $\phi_{max}$  for determining fracture toughness depends on location of crack initiation. Since  $\phi_{max}$  is calculated based on the assumption that fracture initiates from center of disc, Wang and Zing (1999) created pre-existing central crack in FBD samples. Therefore, result of FBD method without pre-existing central crack is just valid when crack initiates from the center of disc. According to the analysis based on Griffith fracture criterion and stress solution for Brazilian test, load angle strongly affects the location of crack initiation (Keles and Tutluoglu, 2011). The minimum load angle at which crack initiates from center of disc is called critical loading angle

**Table 1.** mechanical properties of the target rock.

$E$ (GPa)	$\nu$	$\sigma_c$ (MPa)	$\sigma_t$ (MPa)	$c$ (MPa)	$\varphi$
68	0.2	60	8	10.95	49.88

(wang et al., 2004).

## METHODOLOGY

For laboratory tests, Marble rock extracted from Neiriz quarry mine in Iran was used. Neiriz mine is the biggest construction rock mine in Iran and has the highest rate of extraction and production among all construction rock mines in Iran. This rock is used for many construction purposes. Marble is a metamorphic rock resulting from metamorphism of a very pure limestone or dolomite protolith. At first, mechanical properties of the target rock were determined by results of a triaxial test conducted by MTS 815 loading machine. Obtained values shown in Table 1 also were used for numerical modeling.

### Experimental studies

Wang and Xing (1999) suggested proper FBD specimen geometry. In the present study, samples with different loading angles were prepared according to the proposed specimen geometry by Wang and Xing (1999) (Figure 3). Geometry characteristics are given in Table 2. As shown in Figure 3, loading angle differs from 0 to 40°.

### Sample preparation

Marble block which extracted from mine cored with coring machine in laboratory and cores were cut into disks by clipper machine and core thickness checked by caliper. After preparing disks in required thickness, both sides of disks polished with the help of goniometer to be parallel with corundum polish powder. The specimens which are prepared can be seen in Figure 4.

### Experiments

Experiments were performed by displacement-rate compressional loading machine which apply displacement to specimen, designed and built up by main researcher in Rock Mechanic laboratory of University of Tehran (Iran Patent No. 84659). Tests were conducted on FBD specimens by the aforementioned machine with four tests per each loading angle. Displacement rate in all tests was set to be 0.001 mm/sec. Test procedure on specimens was filmed by a high speed (1000 frame per second) filming camera focused on disks. Then movies were used for primary investigation of crack initiation and propagation path through the specimens.

### Numerical studies

At the first stage of numerical modeling, in order to determine location of crack initiation in Brazilian disc, location of maximum value of tensile stress should be known (Wang and Xing, 1999). So, at the first stage of numerical modeling, dimensionless equivalent stress distribution was modeled based on Griffith criterion. According to Griffith's theory, in Brazilian test, crack initiates at the center when  $3\sigma_1 + \sigma_3 = 0$ , where  $\sigma_1$  and  $\sigma_3$  are maximum

principle stress and minimum principle stress, respectively. However, when the Brazilian disc is flattened, stress condition at the center will change and  $3\sigma_1 + \sigma_3 < 0$  inequality condition governs the tensile crack initiation. Then for tensile strength ( $\sigma_t$ ) estimation, governing expression involving both  $\sigma_1$  and  $\sigma_3$  becomes:

$$\sigma_t = \frac{(\sigma_1 - \sigma_3)^2}{-8(\sigma_1 + \sigma_3)} \quad (3)$$

Left hand side of this equation is also called equivalent stress  $\sigma_G$ , and for Brazilian tensile strength test  $\sigma_G = \sigma_t = 2P_{\max} / \pi Dt$ , where  $P_{\max}$ ,  $D$ , and  $t$  are maximum value of load at failure, disc diameter, and thickness, respectively. Dimensionless equivalent stress  $\bar{\sigma}_G$  (ration of  $\sigma_t$  to  $2P_{\max} / \pi Dt$ ) is used for stress analysis for crack initiation (Hoek and Martin, 2014). At the second stage of numerical modeling, distribution of plastic strain in flattened Brazilian disks were modeled based on Mohr-Coulomb criterion. Mohr-Coulomb criterion is a widely used criterion in the field of geotechnical applications and applies well to rocks. Based on Mohr-Coulomb criterion:

$$\tau = c + \sigma \tan \varphi \quad (4)$$

Where  $\tau$  is shear stress,  $\sigma$  is normal stress,  $c$  is cohesion of material, and  $\varphi$  is angle of friction (Labuz and Zang, 2012).

All numerical modeling of FBD tests were conducted with ABAQUS finite element software. Input parameters are introduced in section 3. In modeling, loading type was set to be ramp loading in which load varies linearly over the step. Surface loads were applied on both flat ends of disks. In first stage of modeling, vertical line passes through the center of disk and both loading surfaces are fixed in all directions and in second stage of modeling, it is fixed in the x and y-direction. In models, element geometry is set to be hexahedron since the accuracy of solutions in hexahedral meshes is the highest. Number of meshes varies depending on the loading angle and the number of meshes along the vertical line passing through the center of specimens as presented in Table 3. Grids are set to be structured due to its highly space efficiency and best fit to Brazilian disks. These Static models have been executed with Standard solution type in the plane stress condition.

## RESULTS AND DISCUSSION

Employing Brazilian test to calculate tensile strength and fracture toughness is based on the assumption that fracture initiates from the center of the disc (Wang and Xing, 1999). However, some researchers proved that fracture initiation under specific loading conditions is a

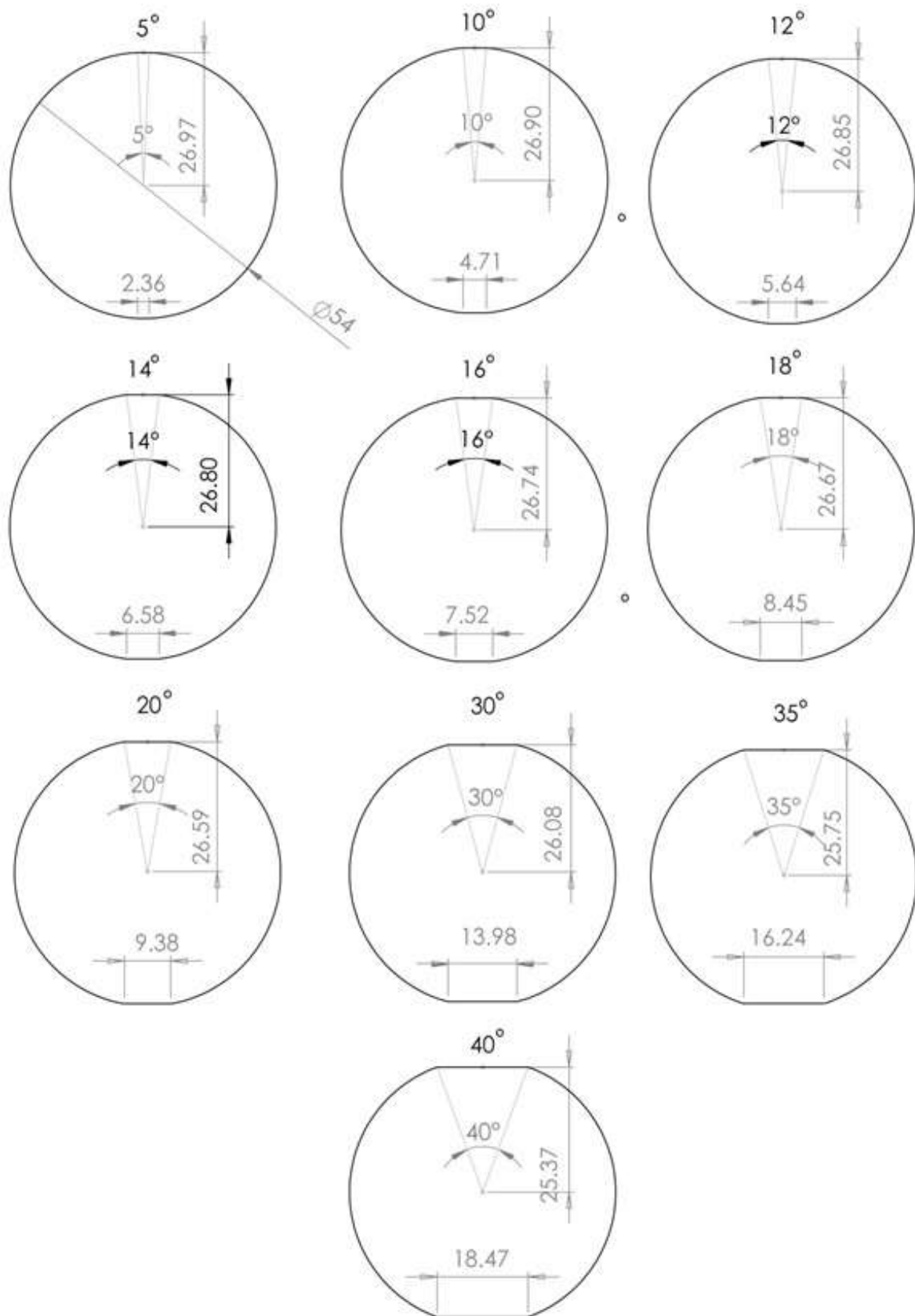

**Figure 3.** Size of samples for investigation of loading angle effect on crack initiation location (mm)

**Table 2.** Geometry characteristics of samples.

D (mm)	t (mm)	2 $\alpha$ (degrees)
54	27	0, 5, 10, 12, 14, 16, 18, 20, 25, 30, 35, and 40

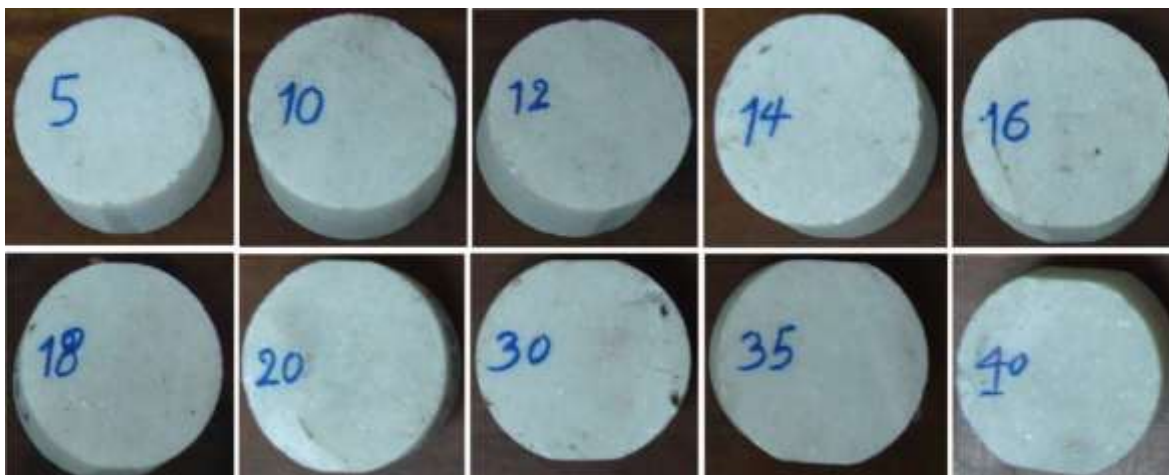
**Figure 4.** Specimens with different loading angles before test.**Table 3.** number of meshes along the vertical line of specimens.

Loading angle (degrees)	Number of meshes through the central vertical line
5	216
10	215
12	214
14	214
16	214
18	213
20	212
30	208
35	206
40	203

them also showed that fracturing does not always initiate at the center of disc (Sarris et al., 2007). Although critical loading angle has been calculated by numerical methods, similar laboratory studies for determining this parameter rarely observed. Hence, in this study, influence of loading angle on the location of crack initiation has been studied experimentally, too.

The results of the plane strain analysis are shown in Figure 5. As it is shown, the relationship between distribution of dimensionless equivalent stress  $\bar{\sigma}_G$  through center of disc and loading angle has been evaluated. As

illustrated in this figure, for loading angles greater than 18 degrees, maximum dimensionless stress occurred at the center of disc, while this maximum stress occurs outside the disc center for loading angles less than 18 degrees.

Similar behavior for samples loaded under different loading angles has been observed in the experiments. As expected, for loading angles less than 18 degrees, crack initiated out of disc center (see Figure 6a) and also for loading angle of 18 degrees fracturing initiates from center of disc (see Figure 6b). Although, good agreement between the numerical models and experimental test was observed for determination of crack initiation location

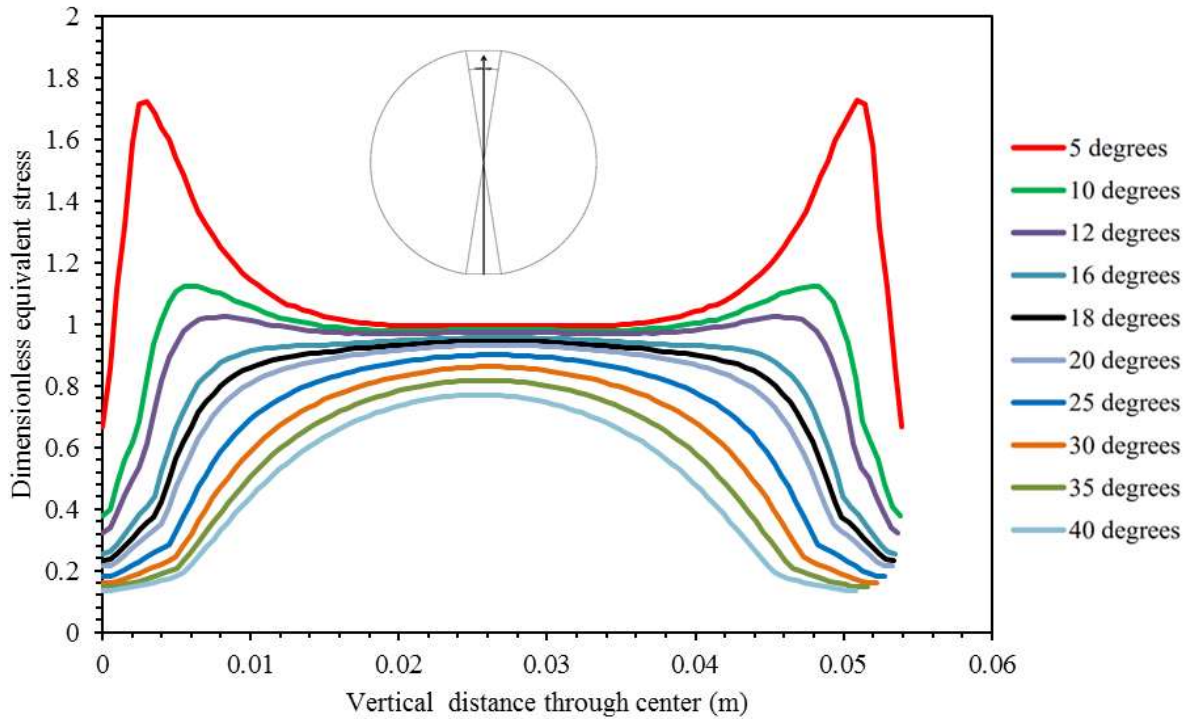

**Figure 5.** Variation of dimensionless equivalent stress in vertical line which passes through the center of specimen.

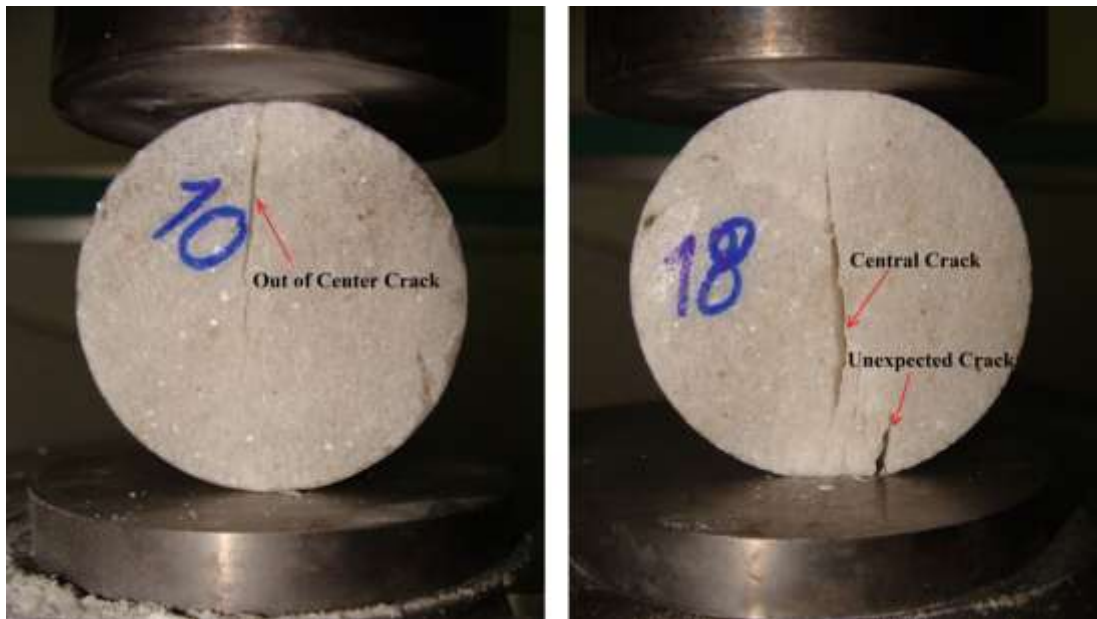

**Figure 6.** Location of crack initiation, (a) for loading angle of 10 degrees that occurs out of disk center and (b) for loading angle of 18 degrees that occurs at disk center.

at different loading angles, some unexpected cracks were detected during the tests (Figure 6b). In such circumstances, occurrence of unexpected cracks can be

explained by inadequate preparation, presence of heterogeneity in rock samples, or existence of pre-microcracks. However, by repeating this test on samples

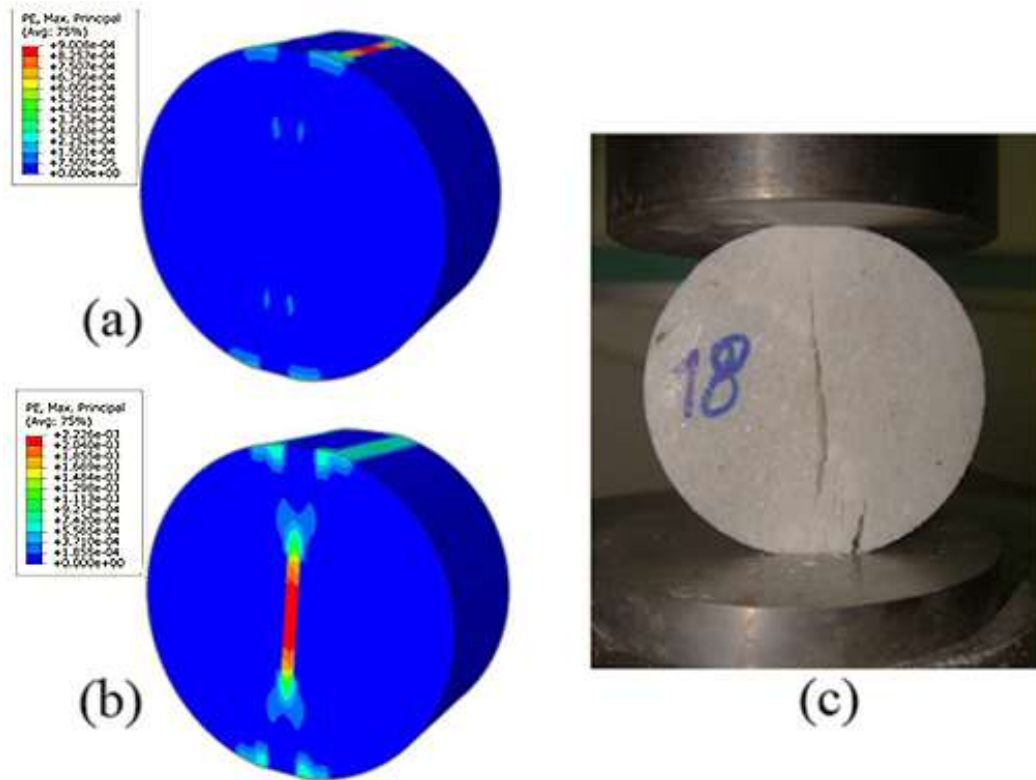

**Figure 7.** Numerical and experimental results of FBD specimen with 18 degrees loading angle (a) Distribution of plastic strain at the first stage of loading, (b) distribution of plastic strain at the last stage of loading and (c) cracks occurred in the specimen.

with loading angles of 18 degrees which have been prepared with high accuracy, it is concluded that mentioned reasons for occurrence of unexpected cracks are not true. Hence, additional numerical studies to determine reasons of occurrence of unexpected cracks were conducted. In order to determine the location of crack initiation under various loading angles and to evaluate reasons of occurrence of unexpected cracks, three dimensional finite element analyses based on Mohr-Coulomb criterion were performed.

Figure 7 shows three dimensional analysis of FBD method with 18 degrees loading angle. Distribution of plastic strain at different stages of loading is shown in this figure. This figure represents the first stage of loading (Figure 7a) as well as the last stage of loading (Figure 7b). As shown in Figure 7, in early stages of loading on sample with loading angle of 18 degrees, plastic strain is generated in flattened ends of sample (where specimen connected to jaws) and in addition to the flat ends, plastic strain is also created in center of disc. By assuming that crack occurs where the plastic strain is created, it can be concluded that central crack initiated after the initiation of crack from flattened ends of sample with loading angle of 18 degrees. Hence, the validity of FBD test with loading angle of 18 degrees is questionable while the performed studies on distribution of dimensionless equivalent stress

$\bar{\sigma}_G$  through center of disc with different loading angles confirmed the validity of this method under the loading angle of more than 18 degrees.

Given the performed analysis, it can be concluded that in order to determine the location of the crack initiation, in addition to dimensionless equivalent stress  $\bar{\sigma}_G$  through the center of the disc, the contact of sample and jaw should be considered. Some other three dimensional analyses have been performed with different loading angles (0, 5, 10, 12, 14, 16, 18, 20, 30, 35, 40). The concluded results can be summarized as follows:

- For loading angles less than 18 degrees, crack initiates from the flattened ends of sample toward center of disc (see Figure 8),
- For loading angles more than 18 and less than 30 degrees, cracks initiate from both center and flattened ends of sample (Figure 7),
- For loading angles more than 30 degrees, crack initiates from center of disc (Figure 9). So, FBD test is valid in this condition.

So, the loading angle of 30 degrees was obtained by experimental and numerical study as an appropriate angle that guarantees initiation of crack from center of disk and prevents occurrence of unexpected cracks at



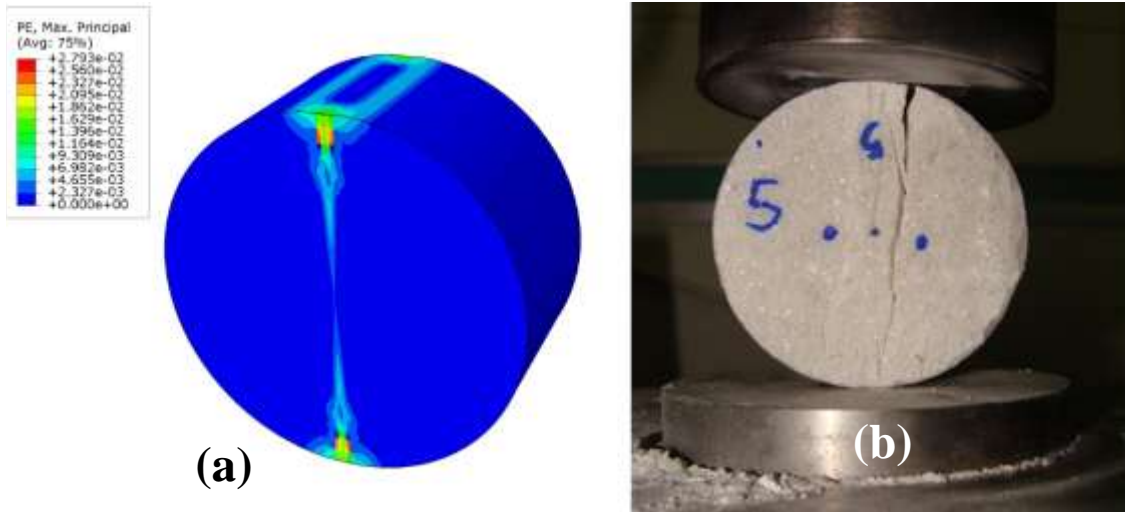

**Figure 8.** Numerical and experimental results of FBD specimen with 5 degrees loading angle (A) Distribution of plastic strain and (B) Location of crack occurred.

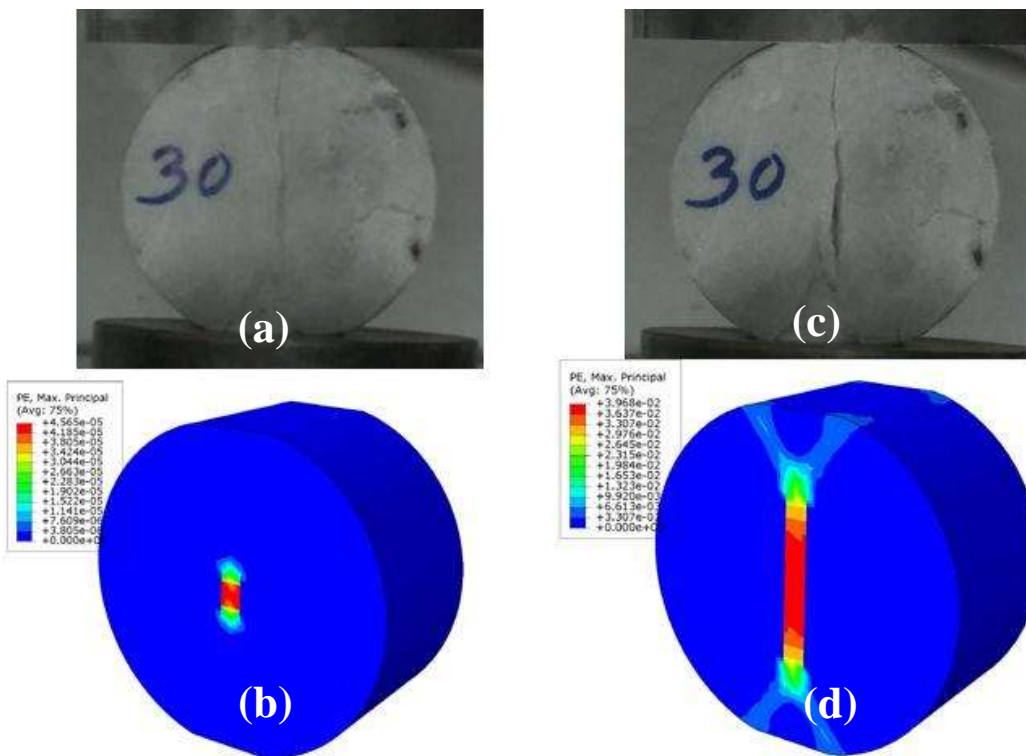

**Figure 9.** Numerical and experimental results of FBD specimen with 30 degrees loading angle (A) Crack occurred at the first stage of loading, (B) Distribution of plastic strain at the first stage of loading, (c) Crack occurred at the last stage of loading and (D) Distribution of plastic strain at the last stage of loading.

flattened ends of specimen. Fracture toughness value of target rock is calculated by the result of one FBD test with 30 degrees loading angle specimen. According to Figure

10 which is the load-vertical displacement graph of one of FBD tests with 30 degrees loading angle, minimum local load could be achieved as 14.7 kN. The fracture

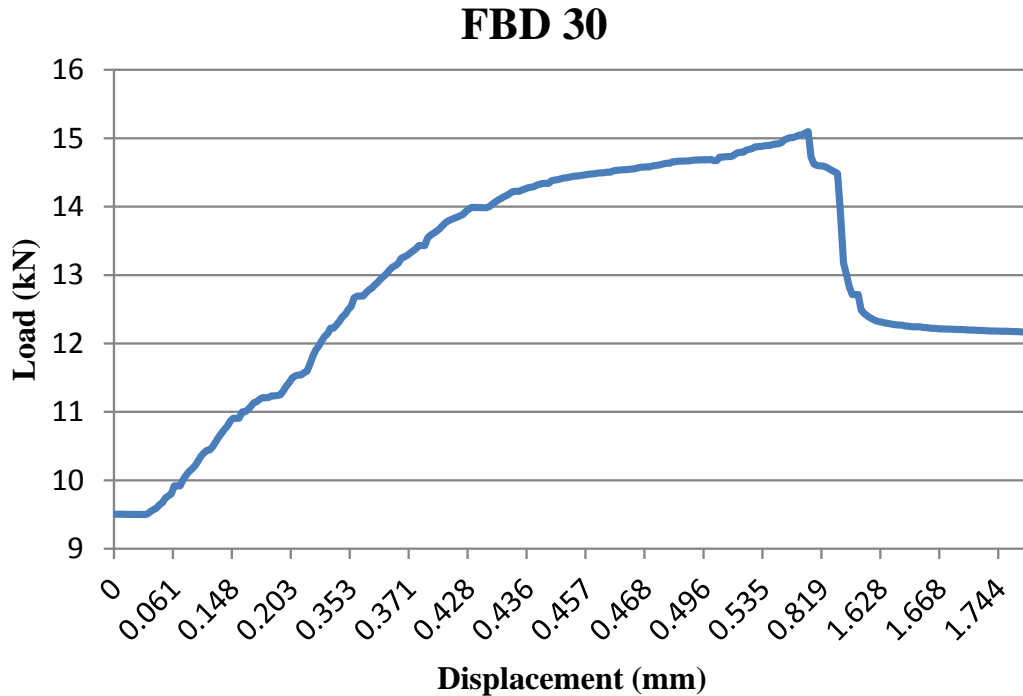

**Figure 10.** load-vertical displacement graph of one of FBD tests with 30 degrees loading angle (note that load should drop to zero after failure but due to the physical contact between remainings of specimen and jaws, vertical load on the specimen didn't relieved completely).

$$K_{Ic} = \frac{P_{\min}}{\sqrt{R} \times t} \phi_{Max}, \phi_{Max} = 0.5895 \quad (\text{for } 2\alpha = 30^\circ)$$

$$K_{Ic} = \frac{0.0147}{\sqrt{0.027 \times 0.027}} 0.5895 = 1.95 \text{MPa}\sqrt{m}$$

## Conclusion

This paper investigated the effect of loading angle on the location of the crack initiation for FBD test because this method is valid only when crack initiates from center of disk. In this regard, experimental and numerical methods were conducted. The two dimensional analysis based on Griffith's theory suggested loading angles more than 18 degrees while three dimensional analysis based on Mohr-Coulomb criterion showed that central cracking occurred for loading angles more than 30 degrees which also avoided cracking at the flattened ends of specimen. Finally, loading angle of 30 degrees was obtained as appropriate loading angle that guarantees initiation of crack from center of disc and prevents occurrence of unexpected cracks at flattened ends of specimen.

## Conflict of interest

The authors have not declared any conflict of interest.

## ACKNOWLEDGEMENT

The contribution of Mr. Hasan Yarmohammadi Samani in performing experiments and modeling is gratefully acknowledged. Mr. Amir Mollajan reviewed the final manuscript and offered a number of valuable comments, which are also acknowledged.

## REFERENCES

- Aliha MRM, Hosseinpour GR, Ayatollahi MR (2013). Application of cracked triangular specimen subjected to three-point bending for investigating fracture behavior of rock materials. *Rock Mech. Rock Eng.* 46(5):1023-1034.
- Alkilicgil C (2010). Development of specimen geometries for mode I fracture toughness testing with disc type rock specimens, Doctoral dissertation, PhD thesis, Middle East Technical University, Ankara.
- Awaji H, Sato S (1978). Combined mode fracture toughness measurement by the disk test. *J. Eng. Mater. Technol.* 100(2):175-182.
- Ayatollahi MR, Aliha MRM (2008). On the use of Brazilian disc specimen for calculating mixed mode I-II fracture toughness of rock materials. *Eng. Fract. Mech.* 75(16):4631-4641.
- Barker LM (1978). Short rod  $K_{Ic}$  measurements of Al<sub>2</sub>O<sub>3</sub>. In *Flaws and Testing*, Springer US pp. 483-494.
- Chen CH, Chen CS, Wu JH (2008). Fracture toughness analysis on cracked ring disks of anisotropic rock. *J. Rock Mech. Rock Eng.* 41(4):539-562.
- Chong K, Kuruppu MD (1984). New specimen for fracture toughness determination for rock and other materials. *Int. J. Fract.* 26(2):R59-R62.
- Chowdhury MS, Song C, Gao W (2014). Probabilistic fracture

- mechanics with uncertainty in crack size and orientation using the scaled boundary finite element method. *J. Comp. Struct.* 137:93-103.
- Dai F, Wei MD, Xu NW, Ma Y, Yang DS (2014). Numerical Assessment of the Progressive Rock Fracture Mechanism of Cracked Chevron Notched Brazilian Disc Specimens. *Rock Mech. Rock Eng.* pp. 1-17.
- Donovan JG, Karfakis MG (2004). Adaptation of a simple wedge test for the rapid determination of mode I fracture toughness and the assessment of relative fracture resistance. *Int. J. Rock Mech. Min. Sci.* 41(4):695-701.
- Guo H, Aziz NI, Schmidt LC (1993). Rock fracture-toughness determination by the Brazilian test. *J. Eng. Geol.* 33(3):177-188.
- Hoek E, Martin CD (2014). Fracture initiation and propagation in intact rock—A review. *J. Rock Mech. Geotech. Eng.* 6(4):287-300.
- Kaklis KN, Agioutantis Z, Sarris E, Pateli A (2005). A theoretical and numerical study of discs with flat edges under diametral compression (flat Brazilian test). In 5th GRACM Int. Congress Comput. Mech. 1:437-444.
- Keles C, Tutluoglu L (2011). Investigation of proper specimen geometry for mode I fracture toughness testing with flattened Brazilian disc method. *Int. J. Fract.* 169(1):61-75.
- Khavari P (2015). Investigation and Comparison between Methods of Determining the crack Toughness in Rocks, Iranian National Conference on Geology and Resources Exploration (In Persian).
- Labuz JF, Arno Z (2012). "Mohr–Coulomb failure criterion." *The ISRM Suggested Methods for Rock Characterization, Testing and Monitoring: 2007-2014.* Springer Int. Publishing pp. 227-231.
- Ouchterlony F (1981). Extension of the compliance and stress intensity formulas for the single edge crack round bar in bending. *ASTM STP 745:237-256.*
- Ouchterlony F (1988). Suggested methods for determining the fracture toughness of rock. *Int. J. Rock Mech. Min. Sci.* 25(2):71-96.
- Rocco C, Guinea GV, Planas J, Elices M (1999). Size effect and boundary conditions in the Brazilian test: experimental verification. *J. Mat. Struct.* 32(3):210-217.
- Roylance D (2001). *Introduction to fracture mechanics.* Massachusetts Institute of Technology, Cambridge.
- Sarris E, Agioutantis Z, Kaklis K, Kourkoulis SK (2007). Numerical Simulation of the Cracked Brazilian Disc under Diametral Compression. In *Bifurcations, Instabilities, Degradation in Geomechanics,* Springer Berlin Heidelberg 403-430.
- Sheity DK, Rosenfield AR, Duckworth WH (1985). Fracture Toughness of Ceramics Measured by a Chevron-Notch Diametral-Compression Test. *J. Am. Ceram. Soc.* 68(12):C-325.
- Szendi-Horvath G (1980). Fracture toughness determination of brittle materials using small to extremely small specimens. *J. Eng. Fract. Mech.* 13(4):955-961.
- Thiercelin M, Roegiers JC (1986). Fracture toughness determination with the modified ring test. In *Proc. Int. symp. Eng. Complex Rock Formation,* Beijing, China pp. 1-8.
- Wang QZ, Jia XM, Kou SQ, Zhang ZX, Lindqvist PA (2004). The flattened Brazilian disc specimen used for testing elastic modulus, tensile strength and fracture toughness of brittle rocks: analytical and numerical results. *Int. J. Rock Mech. Min. Sci.* 41(2):245-253.
- Wang QZ, Wu LZ (2004). The flattened Brazilian disc specimen used for determining elastic modulus, tensile strength and fracture toughness of brittle rocks: experimental results. *Int. J. Rock Mech. Mining Sci.* 41:26-30.
- Wang QZ, Xing L (1999). Determination of fracture toughness  $K_{Ic}$  by using the flattened Brazilian disk specimen for rocks. *J. Eng. Fract. Mech.* 64(2):193-201.

## NOMENCLATURE

$2\alpha$	Loading angle	$\alpha$	Half of the loading angle
$2L$	Flattened end width	$\sigma$	Normal stress
$a$	Crack length	$\sigma_1$	Maximum principal stress
$c$	Cohesion	$\sigma_3$	Minimum principal stress
$D$	Specimen diameter	$\sigma_c$	Compressional strength
$E$	Elastic modulus	$\sigma_t$	Tensional strength
$K_I$	Mode I stress intensity factor	$\sigma_G$	Equivalent stress
$K_{Ic}$	Mode I critical stress intensity factor or mode I fracture toughness	$\bar{\sigma}_G$	Dimensionless equivalent stress
$P$	Applied load	$\tau$	Shear stress
$P_{max}$	Maximum local load	$\nu$	Poisson's ratio
$P_{min}$	Minimum local load	$\phi_{max}$	Dimensionless maximum stress intensity factor
$R$	Specimen radius	$\varphi$	Internal friction angle
$t$	Specimen thickness		