

Full Length Research Paper

Mechanical properties of interlaminar Kevlar²⁹ and Al₂O₃ powder/epoxy composite plates using an analytical approach

A. R. Abu Talib¹, L. H. Abbud^{1*}, Aidy Ali², F. Mustapha¹

¹Department of Aerospace Engineering, Universiti Putra Malaysia, 43400 Selangor, Malaysia.

²Department Mechanical Engineering, Universiti Putra Malaysia, 43400 Selangor, Malaysia.

Accepted 22 August, 2011

In this study, the behaviour of laminated composite plates, fiber Kevlar²⁹, Al₂O₃ powder/epoxy and the suggested analytical solution for static analysis of composite plates were presented using general classical laminated plate theory. The Navier solutions are limited to simply support rectangular plates using static analysis. The results show that the effect of the deflections and stresses on the plate thickness-to-length ratio, aspect ratio, modulus ratio, fiber orientation and the number of layers were observed. The deflection and stresses on laminated composite plate decreases with the increase in the number of layers, fiber orientation, and thickness of the laminated plates. These results indicate that the improvements in mechanical properties for aircraft body applications were achieved.

Key words: Composite materials, laminated plates, mechanical properties, Navier solution, deflection plate.

INTRODUCTION

Composite materials are defined as a combination of two or more materials that have quite different properties, which offer more desirable and unique properties than the individual materials. As a result, it can also be noted that the combination of materials do not dissolve or blend into each other, and the theory behind the construction of composite materials comes from the need to create strong, stiff, and light materials. Materials such as glass, carbon and Kevlar have extremely high tensile and compressive strength, but in solid form, many random surface flaws are present in such materials, which cause them to crack and fail at a much lower stress than it theoretically should. Fiber-reinforced composite materials are continuing to replace the conventional metals in primary and secondary aerospace and aircraft structural elements owing to their superior mechanical properties such as high strength-to-weight stiffness-to-weight ratios. One form of these materials being used in current design studies of aircraft is the unidirectional fiber-reinforced lamina (Vasiliev and Morozov, 2001).

The modified theory was then used to develop a new finite element model for the analysis of thick laminated

plates composed of arbitrarily-oriented layers. The proposed finite element method was assessed for its performance, comparing its solution for three-layered square and rectangular laminates and FRP-faced square sandwich laminates with that of the three-dimensional elasticity solution. The central deflection and in-plane stresses are evaluated by varying the fiber orientation angle in the top and bottom layers of a rectangular laminate (Rao and Meyer-Piening, 1990). A unique approach to analyzing thick laminated composites was done by presenting two simple finite element methods. The first method used the Predictor-Corrector technique to extend the simple Mindlin-type element to achieve greater accuracy, and the second developed a new Least Squares element that can approximate a C1 continuous element.

The Carbon-nanotubes (CNTs) have been used with polymers from the date of their inception to make composites having remarkable properties (Kanagaraj et al., 2007). It was shown that by combining the exact (Navier) solution of the specially orthotropic plate equilibrium equations with the Tsai-Hill failure criterion the initial failure analysis of fibre-reinforced laminated plates may be transformed into an optimization problem. A simple trial and error procedure was used to locate and evaluate the maximum value of an initial failure function

*Corresponding author. E-mail: luayhashem@yahoo.com.

from which the initial failure load and the corresponding plate deflections were derived. This approach was used to provide design data for the initial failure conditions in GFRP and CFRP simply-supported rectangular plates were subjected to uniform, uniform square patch and hydrostatic (linearly varying) load distributions. (Turvey, 1980) The resulting transcendental equilibrium equation was dependent upon the unknown neutral surface. This neutral surface was found and, hence, the equilibrium problem was solved with an iteration technique.

The approach was applied to laminates ordinarily thought to be symmetric, asymmetric, and un-symmetric about the middle surface. All laminates were found to exhibit coupling between bending and extension under bending in contrast to the usual concepts of symmetry and asymmetry for single modulus laminates. The effect of coupling due to different moduli in tension and compression on stresses and deflections is found to be generally significant for common composite materials such as boron/epoxy and graphite/epoxy as well as carbon-carbon (Jones and Morgan, 1980). The impact behaviour of single and multi-ply Kevlar 129 fabric armour systems was investigated using an explicit finite element code, TEXIM, developed in-house. A numerical model was used by (Novotny et al., 2007) to explore the loss in ballistic efficiency of woven fabric targets, as experienced early in the impact event. The effects of plate width-to-thickness ratio, fibre orientation, number of layers, thickness ratio, aspect ratio and boundary conditions on the displacement and stress response of symmetric and asymmetric laminated composite plates subjected to uniformly distribute normal loads were studied.

The non-dimensional central deflections have been decreased with an increase in the plate width-to-thickness ratio. The central deflection approaches a minimum of a 45° fibre orientation. The number of layers does not have much effect on the central deflection beyond six layers (Latheswary, et al., 2004).

The overall goal of this research is to investigate the response of composite materials (alumina powder and fiber composite Kevlar-29 with epoxy resin), to predict the failure of delamination composite laminate plates theoretically by using rectangular plate with different angles of fiber orientation (θ) for each layer and deriving equations for evaluating defalcation and stresses. In this study the suggested analytical solution for static analysis of composite plates is presented using the general classical laminated plate theory (CLPT). The Navier solutions are limited to simple supported rectangular plates using static analysis.

MICRO-MECHANICAL BEHAVIOR OF LAMINA

The mechanics of the materials approach is that certain simplifying assumptions are made regarding the mechanical behavior of a composite material. The most prominent assumption is that the

strains in the direction of the fiber of a unidirectional fibrous composite are the same in the fiber as in the matrix. Since the strain in both matrix and fiber are the same, it is obvious that sections normal to the 1-axis that were planed before being stressed remain planed after stressing. The foregoing is a prominent assumption in the usual mechanics of materials approaches such as in beam, plate, and shell theories. The basis, the mechanics of materials expressions will be derived for the apparent orthotropic moduli of a unidirectionally-reinforced fibrous composite material.

Composite reinforcement

Composite reinforcement by particle (Al_2O_3 + epoxy)

The quantity of the particle that was added to the matrix material to manufacture the composite material was calculated by the weight fraction and the equal ratio of the particle weight to the composite material weight (Decolon, 2002):

$$V_m = 1 - V_p \quad 1$$

$$W_m = \frac{W_m}{W_i} \quad 2$$

The mass (m_i) of the composite is made up of the masses of the matrix (m_m) and the filler particle (m_p):

$$m_i = m_m + m_p \quad 3$$

By re – writing Equation (3) in form of volume and density:

$$v_i \rho_i = v_m \rho_m + v_p \rho_p \quad 4$$

By dividing by v_i , Equation (4) becomes:

$$\rho_i = \frac{v_m}{v_i} \rho_m + \frac{v_p}{v_i} \rho_p \quad 5$$

$\frac{v_m}{v_i} = V_m$, which is the volume fraction for the matrix, and $\frac{v_p}{v_i} = V_p$, which is the volume fraction for the powder .

$$\rho_i = V_m \rho_m + V_p \rho_p \quad 6$$

Note that since $V_m = V_i - V_p$ it must have

$$V_m = 1 - V_p \quad 7$$

By substituting Equation (7) into Equation (6) gives us:

$$\rho_i = \rho_m (1 - V_p) + \rho_p V_p = \rho_m + V_p (\rho_p - \rho_m)$$

$$E_i = E_p V_p + (1 - V_p) E_m \quad 8$$

Composite reinforcement by fiber and (Al2O3 +epoxy)

The mass of the composite is:

$$m_c = m_f + m_i \quad 9$$

So"

m_c : the mass of the composite
 m_f : the mass of the fiber
 m_i : this mass from Equation (3)

$$v_c \rho_c = v_f \rho_f + v_i \rho_i \quad 10$$

Then:

so $V_f = \frac{v_f}{v_c}$ is the volume fraction of the fiber

and $V_i = \frac{v_i}{v_c}$ is the volume fraction of the particles and epoxy

And noting that $V_i + V_f = 1$, the density of the composite is given as:

$$\rho_c = V_f \rho_f + V_i \rho_i = V_f \rho_f + (1 - V_f) \rho_i \quad 11$$

Determination of E1: The first modulus to be determined is that of the composite in the 1–direction, that is, in the fiber direction.

$$E_1 = E_f V_f + (1 - V_f) E_i$$

Determination of E2: The apparent Young's modulus (E2) in the direction transverse to the fiber is considered next.

$$E_2 = \frac{E_f E_i}{V_i E_f + V_f E_i}$$

Determination of u12 : The so–called major Poisson's ratio (u12) can be obtained by an approach similar to the analysis for E1. The major Poisson's ratio is:

$$v_{12} = V_i v_i + V_f v_f$$

Determination of G12: The in–plane shear modulus of a lamina (G12) is determined in the mechanics of materials approach by assuming that the shearing stresses on the fiber and composite material by the particles are the same.

$$G_{12} = \frac{G_i G_f}{V_i G_f + V_f G_i}$$

MACRO-MECHANICAL BEHAVIOR OF A LAMINA

The study of composite material behavior is where the material is

presumed homogeneous; the effects of the constituent materials are detected only as averaged apparent properties of the composite. The stress and strain relationship as shown by (Crawford, 1998):

$$\epsilon_x = \frac{\sigma_x}{E_1} - v_{12} \frac{\sigma_y}{E_2} \quad 12$$

$$\epsilon_y = \frac{\sigma_y}{E_2} - v_{21} \frac{\sigma_x}{E_1} \quad 13$$

The relation between shear stress τ_{xy} and the shear modulus G_{12} is given by:

$$\gamma_{xy} = \frac{\tau_{xy}}{G_{12}} \quad 14$$

In the analysis of composites, it is convenient to use matrix notation because this simplifies the computations very considerably. Thus we may write the above equations as:

$$\begin{bmatrix} \epsilon_x \\ \epsilon_y \\ \gamma_{xy} \end{bmatrix} = \begin{bmatrix} \frac{1}{E_1} & -\frac{v_{21}}{E_2} & 0 \\ -\frac{v_{12}}{E_1} & \frac{1}{E_2} & 0 \\ 0 & 0 & \frac{1}{G_{12}} \end{bmatrix} \begin{bmatrix} \sigma_x \\ \sigma_y \\ \tau_{xy} \end{bmatrix}$$

Or in abbreviated form:

$$[\epsilon] = [S][\sigma] \text{ and } [\sigma] = [S]^{-1}[\epsilon] \quad 15$$

Where $[S]$ is called the compliance matrix.

Using matrix notation, Equation (15) may be transposed to give the stresses as a function of the strains:

$$[\sigma] = [S]^{-1}[\epsilon]$$

This may also be written as:

$$[\sigma] = [Q][\epsilon] \text{ and } [Q] \quad 16$$

Where $[Q]$ is the stiffness matrix and its terms will be:

$$Q_{11} = \frac{E_1}{1 - v_{12} v_{21}}, \quad Q_{22} = \frac{E_2}{1 - v_{21} v_{12}}, \quad Q_{66} = G_{12}$$

$$Q_{12} = Q_{21} = \frac{v_{12} E_2}{1 - v_{12} v_{21}} = \frac{v_{21} E_1}{1 - v_{21} v_{12}}$$

$$Q_{16} = Q_{61} = Q_{26} = Q_{62} = 0$$

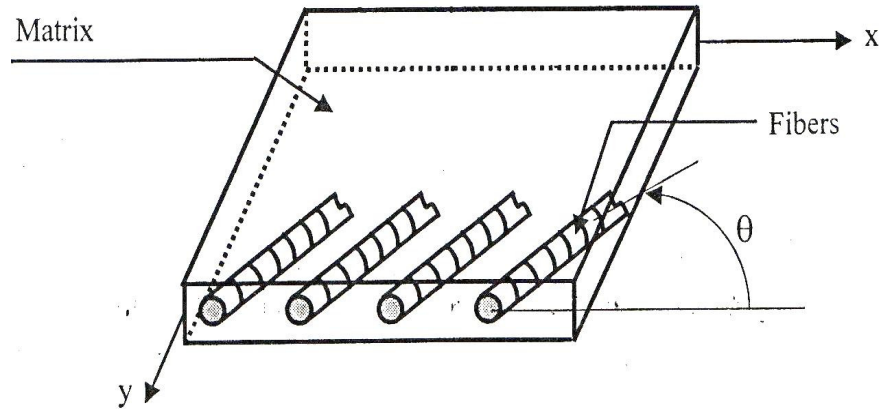

Figure 1. Unidirectional reinforced lamina.

The previous analysis is a preparation for the more interesting and practical situation where the applied loading axis does not coincide with the fiber axis; this is illustrated in Figure 1.

$$\sigma_1 = \sigma_x \cos^2 \theta + \sigma_y \sin^2 \theta + 2\tau_{xy} \sin \theta \cos \theta$$

$$\sigma_2 = \sigma_x \sin^2 \theta + \sigma_y \cos^2 \theta - 2\tau_{xy} \sin \theta \cos \theta$$

$$\tau_{12} = -\sigma_x \sin \theta \cos \theta + \sigma_y \sin \theta \cos \theta + \tau_{xy} (\cos^2 \theta - \sin^2 \theta)$$

Using matrix notation:

$$\begin{bmatrix} \sigma_1 \\ \sigma_2 \\ \tau_{12} \end{bmatrix} = \begin{bmatrix} c^2 & s^2 & 2sc \\ s^2 & c^2 & -2sc \\ -sc & sc & (c^2 - s^2) \end{bmatrix} \begin{bmatrix} \sigma_x \\ \sigma_y \\ \tau_{xy} \end{bmatrix} \tag{17}$$

$$\tau_{12} = -\sigma_x \sin \theta \cos \theta + \sigma_y \sin \theta \cos \theta + \tau_{xy} (\cos^2 \theta - \sin^2 \theta),$$

$$[\sigma]_{12} = [T_\sigma][\sigma_{xy}] \text{ and } [T_\sigma]$$

Where $c = \cos \theta$ and $s = \sin \theta$.

In shorthand form, this matrix equation may be written as:

$$[\sigma]_{12} = [T_\sigma][\sigma_{xy}]$$

Where $[T_\sigma]$ is called the stress transformation matrix; similar transformations may be made for the strains so that:

$$\begin{bmatrix} \epsilon_1 \\ \epsilon_2 \\ \frac{1}{2}\gamma_{12} \end{bmatrix} = [T_\epsilon] \begin{bmatrix} \epsilon_x \\ \epsilon_y \\ \frac{1}{2}\gamma_{xy} \end{bmatrix}, \quad \begin{bmatrix} \sigma_x \\ \sigma_y \\ \tau_{xy} \end{bmatrix} = [T_\sigma]^{-1} \begin{bmatrix} \sigma_1 \\ \sigma_2 \\ \tau_{12} \end{bmatrix}$$

18

$$[T_\sigma]^{-1} = \begin{bmatrix} c^2 & s^2 & -2sc \\ s^2 & c^2 & 2sc \\ sc & -sc & (c^2 - s^2) \end{bmatrix}$$

$$\begin{bmatrix} \epsilon_1 \\ \epsilon_2 \\ \gamma_{12} \end{bmatrix} = \begin{bmatrix} c^2 & s^2 & sc \\ s^2 & c^2 & -sc \\ -2sc & 2sc & (c^2 - s^2) \end{bmatrix} \begin{bmatrix} \epsilon_x \\ \epsilon_y \\ \gamma_{xy} \end{bmatrix}$$

Note the modification to $[T_\sigma]$ gives the strain transformation matrix T_ϵ

$$\begin{bmatrix} \sigma_1 \\ \sigma_2 \\ \tau_{12} \end{bmatrix} = \begin{bmatrix} Q_{11} & Q_{12} & 0 \\ Q_{21} & Q_{22} & 0 \\ 0 & 0 & Q_{66} \end{bmatrix} \begin{bmatrix} \epsilon_1 \\ \epsilon_2 \\ \gamma_{12} \end{bmatrix}$$

$$\begin{bmatrix} \sigma_x \\ \sigma_y \\ \tau_{xy} \end{bmatrix} = \begin{bmatrix} c^2 & s^2 & -2sc \\ s^2 & c^2 & 2sc \\ sc & -sc & (c^2 - s^2) \end{bmatrix} \begin{bmatrix} \sigma_1 \\ \sigma_2 \\ \tau_{12} \end{bmatrix}$$

$$\begin{bmatrix} \sigma_x \\ \sigma_y \\ \tau_{xy} \end{bmatrix} = \begin{bmatrix} c^2 & s^2 & -2sc \\ s^2 & c^2 & 2sc \\ sc & -sc & (c^2 - s^2) \end{bmatrix} \begin{bmatrix} Q_{11} & Q_{12} & 0 \\ Q_{21} & Q_{22} & 0 \\ 0 & 0 & Q_{66} \end{bmatrix} \begin{bmatrix} c^2 & s^2 & sc \\ s^2 & c^2 & -sc \\ -2sc & 2sc & (c^2 - s^2) \end{bmatrix} \begin{bmatrix} \epsilon_x \\ \epsilon_y \\ \gamma_{xy} \end{bmatrix}$$

Which provides an overall stiffness matrix $\begin{bmatrix} - \\ - \\ - \end{bmatrix} Q$

Where:

$$\begin{bmatrix} \sigma_x \\ \sigma_y \\ \tau_{xy} \end{bmatrix} = \begin{bmatrix} - \\ - \\ - \end{bmatrix} \begin{bmatrix} \epsilon_x \\ \epsilon_y \\ \gamma_{xy} \end{bmatrix} \quad (19)$$

The displacement (w) yield expressions for the strains ϵ_x , ϵ_y and γ_{xy} at any point of the plate.

$$\epsilon_x = -z \frac{\partial^2 w}{\partial x^2}$$

$$\epsilon_y = -z \frac{\partial^2 w}{\partial y^2}$$

$$\gamma_{xy} = -2z \frac{\partial^2 w}{\partial x \partial y}$$

The rectangular plate, in general, has two sides a and b, where the plate is simply supported on all edges and subjected to a distributed constant load P0 (Vinson, 2005). This approach is called the 'Navier' solution. The boundary conditions can then be formulated as:

$$w(x,0) = 0 \quad w(x,b) = 0 \quad w(0,y) = 0 \quad w(a,y) = 0$$

The method consists of a Fourier serial development of an arbitrary load like the following:

$$p(x,y) = \sum_{m=1}^M \sum_{n=1}^N p_{mn} \sin \frac{m\pi}{a} x \sin \frac{n\pi}{b} y$$

Where the load factor p_{mn} for each m,n can be taken from tables or calculated by standard Fourier coefficient calculations, expressed as:

$$p_{mn} = \frac{4}{ab} \int_0^a \int_0^b p(x,y) \sin \frac{m\pi}{a} x \sin \frac{n\pi}{b} y \, dx \, dy \quad (20)$$

We can now express the displacement function as a Fourier series:

$$w(x,y) = \sum_{m=1}^M \sum_{n=1}^N C_{mn} \sin \frac{m\pi}{a} x \sin \frac{n\pi}{b} y$$

Where each load contribution

$$p_{mn} \sin \left(\frac{m\pi}{a} x \right) \sin \left(\frac{n\pi}{b} y \right)$$

has its own displacement expressed as:

$$w_{mn}(x,y) = C_{mn} \sin \left(\frac{m\pi}{a} x \right) \sin \left(\frac{n\pi}{b} y \right)$$

C_{mn} is given by the equation:

$$C_{mn} = \frac{P_{mn}}{\pi^4 D \left[\left(\frac{m}{a} \right)^2 + \left(\frac{n}{b} \right)^2 \right]^2}$$

And the displacement then becomes:

$$w(x,y) = \sum_{m=1}^M \sum_{n=1}^N \frac{P_{mn}}{\pi^4 D \left[\left(\frac{m}{a} \right)^2 + \left(\frac{n}{b} \right)^2 \right]^2} \sin \left(\frac{m\pi}{a} x \right) \sin \left(\frac{n\pi}{b} y \right)$$

Where p_{mn} is given by the first expression in Equation (20). For the case when the load $p(x,y)$ is a constant p_0 , after one integration.

$$P_{mn} = \frac{16p_0}{\pi^2 mn}$$

$$w = \frac{16p_0}{\pi^6 D} \sum_{m=1}^M \sum_{n=1}^N \frac{\sin \left(\frac{m\pi}{a} x \right) \sin \left(\frac{n\pi}{b} y \right)}{mn \left[\left(\frac{m}{a} \right)^2 + \left(\frac{n}{b} \right)^2 \right]^2}$$

This equation is the solution for the vertical displacement of the composite plate.

RESULTS AND DISCUSSION

In discussing the deflection results for composite laminated plates are under different constant loads, the results are the response, stresses and inter – laminar shear stresses solution by first order shear deformation theory for symmetric, cross – ply and angle – ply, laminate plats subjected to the static loading. Square simply supported four-layer laminated plates with layers of equal thickness and subjected to uniformly distributed load are considered to study the effect of the plate width-to-thickness ratio. Both cross-ply and angle-ply laminates with symmetric is analyzed. The elasticity method of structural analysis embodies the determination of stresses and/or displacements by employing equations of equilibrium and compatibility in conjunction with the relevant force–displacement or stress–strain relationships, so the maximum loads on the components of an aircraft's structure generally occur when the aircraft is undergoing some form of acceleration or deceleration, such as in landings, take-offs and manoeuvres within the flight and gust envelopes. The results are shown in Figures 2 to 4. It is seen from Figure 4 that the central deflection decreases with increase in b/h ratio up to b/h = 20 and then remains practically constant in all cases.

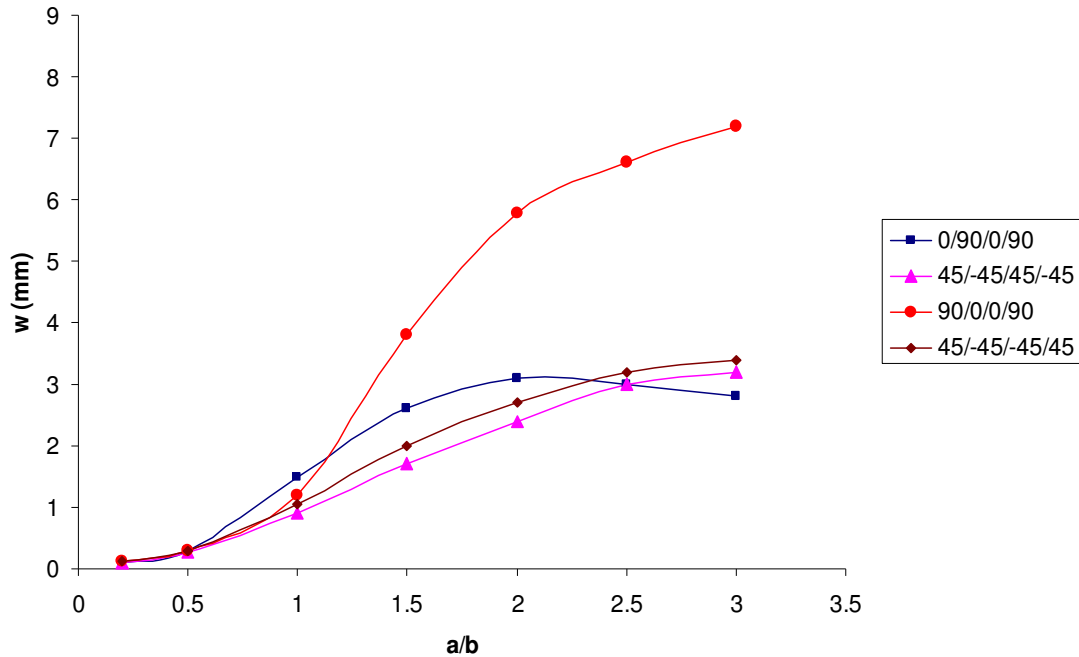

Figure 2. Central deflection for different fiber orientations of laminated plates with the aspect ratio.

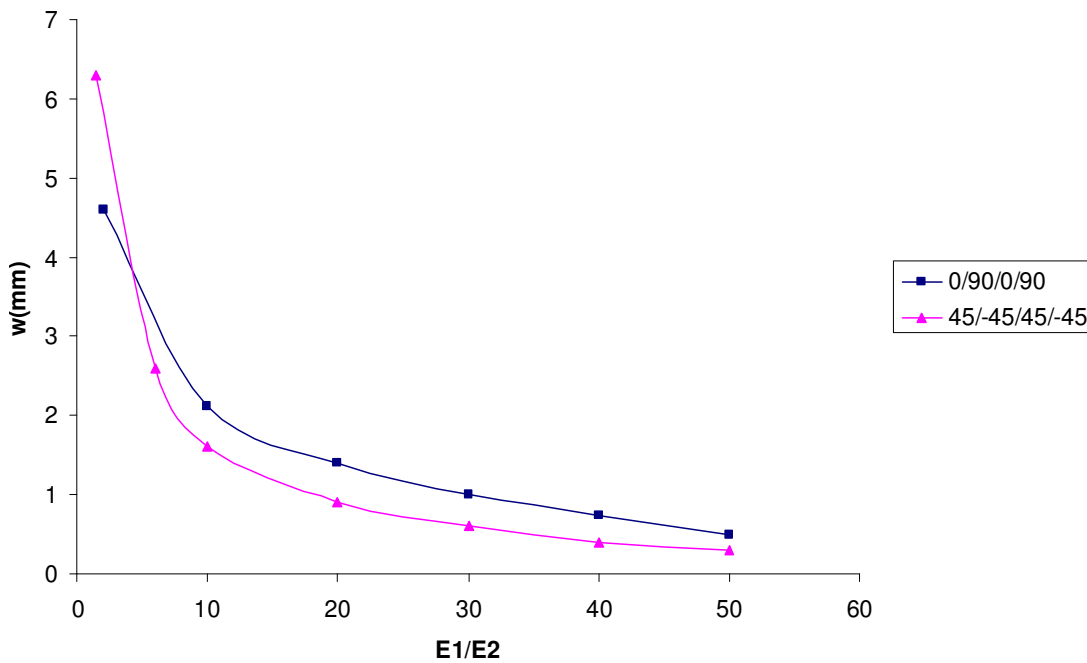

Figure 3. Central deflection for different fiber orientations of laminated plates with the E1/E2 ratio.

These results compared with element formulation done by Latheswary et al. (2004). The results for deflections, stresses are presented showing the effect of plate side – to – thickness ratio, aspect ratio, and material orthotropic.

Figure 2 shows the effect of the aspect ratio on the deflection for different fiber orientations. It is noted that

the deflection of the laminated plate increases with an increase in the aspect ratio. And it is also affected by the number of layers, thickness and the modulus ratio. Figure 3 shows the effect of the (E1/E2) ratio on the deflection of cross-ply and angled-ply laminated plates for simply supported laminated plates. The deflection of laminated

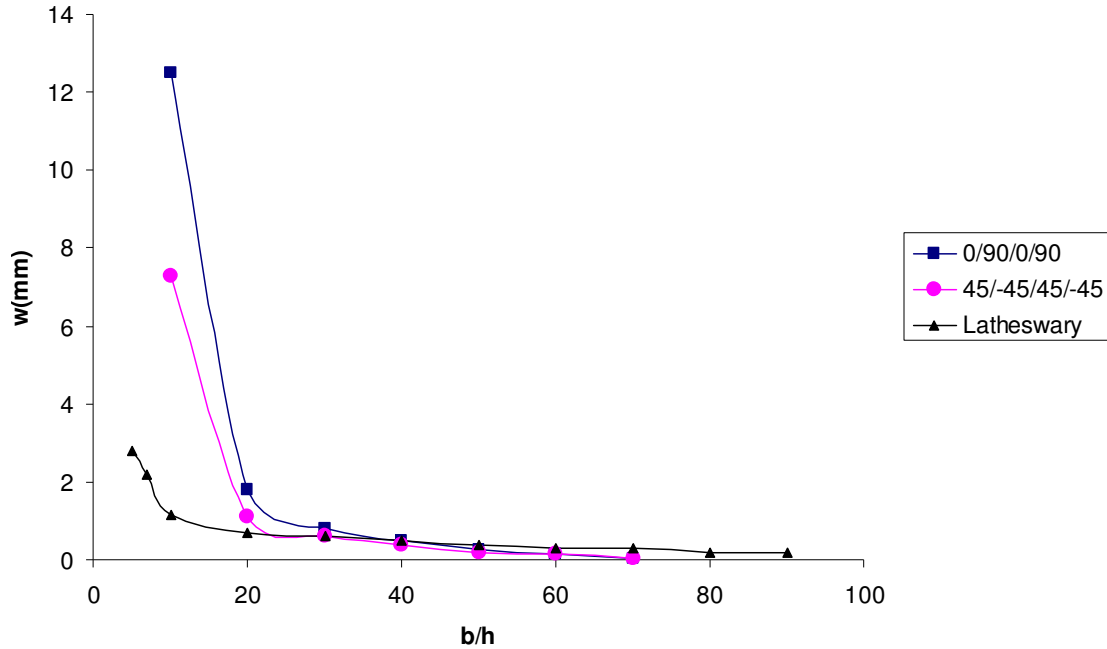

Figure 4. Central deflection for different fiber orientations of laminated plates with different b/h ratios.

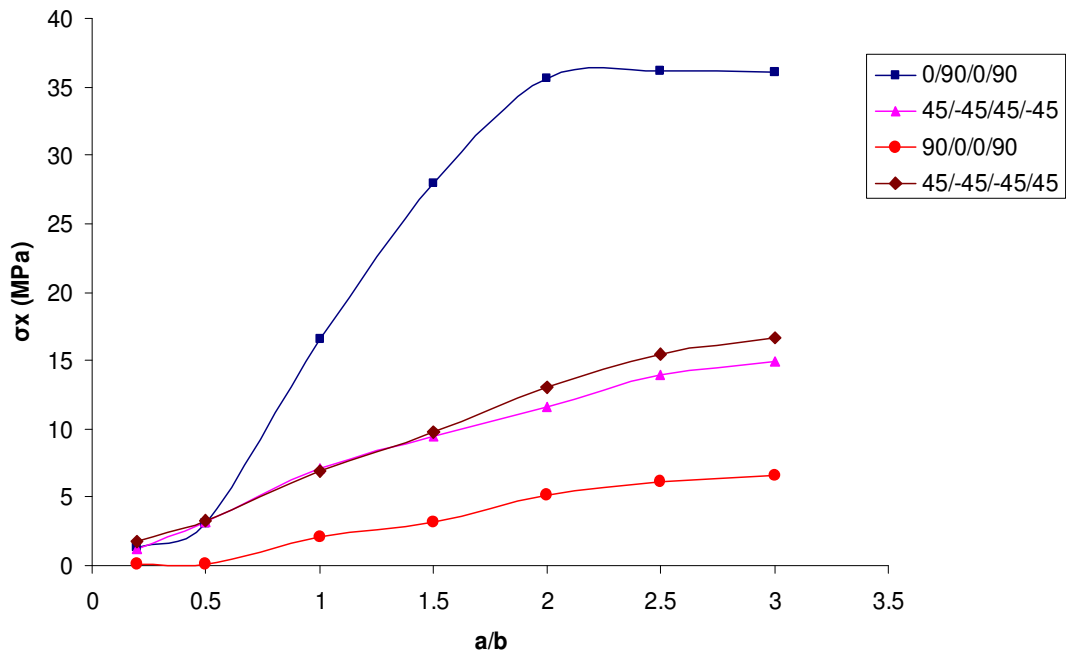

Figure 5. Stress σ_x for different fiber orientations of laminated plates with the aspect ratio.

plates decreases with an increase in the (E_1/E_2) ratio. Figure 4 shows the (b/h) ratio of simply supported cross-ply and angled-ply laminated plates and the results were compared with finite element formulation done by Latheswary et al. (2004).

It is clear that the deflection of laminated plates decreases with an increase in the (h/a) ratio, and its deflection decreases with an increase in h . The static analysis of composite laminated plates is obtained by using an analytical solution and the results show the

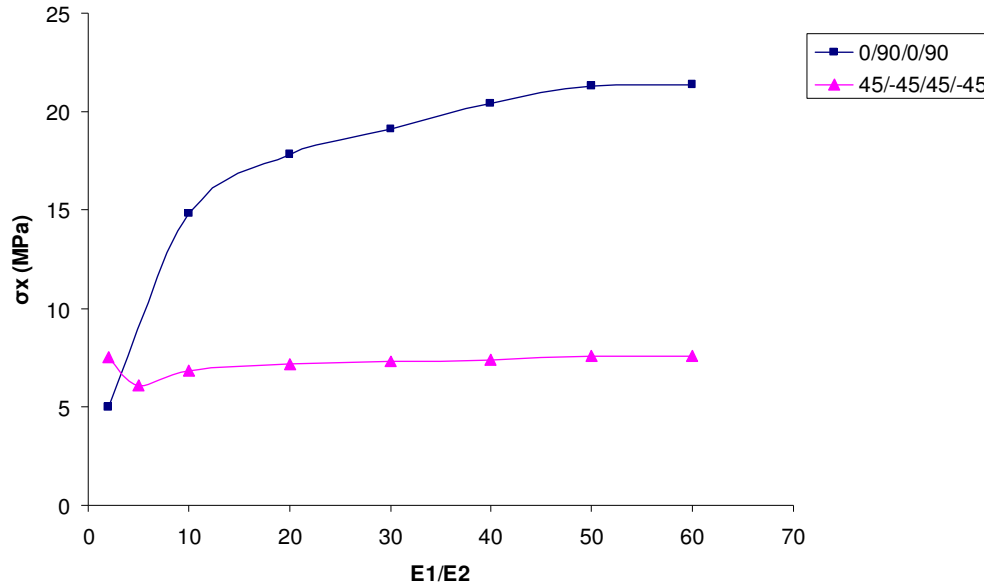

Figure 6. Stress σ_x for different fiber orientations of laminated plates with the $E1/E2$ ratio.

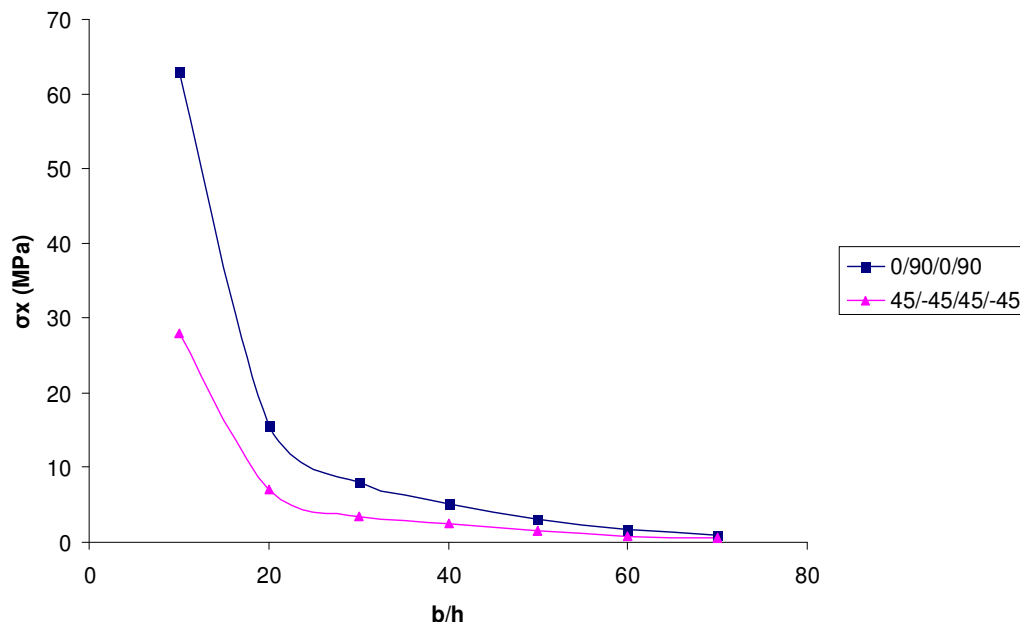

Figure 7. Stress σ_x for different fiber orientations of laminated plates with different b/h ratios.

effect of the aspect ratio, modulus ratio and fiber orientation on the stress in the x-direction. Figure 5 shows the effect of the aspect ratio on the maximum stress σ_x for different fiber orientations for composite laminate plates. The figure shows that the stress σ_x increase with the increasing of the aspect ratio. Figure 6 shows the effect of the $(E1/E2)$ ratio and the stress σ_x for cross-ply and angled-ply, with simply supported laminated plates.

The figure shows that the stress σ_x increases with an increase of the $(E1/E2)$ ratio and its increase with an increase in $E1$. In addition, the σ_x for the angled-ply laminated plate was less than the cross-ply laminated plate. The effect of the (b/h) ratio is shown in Figure 7, with the stress σ_x for the cross-ply laminate and the angle-ply laminate; the figure shows that the stress σ_x decreases with an increase in the (h/a) ratio and that it decreases with an increase in the thickness (h) .

Conclusions

The main conclusions for this study are as follows:

1. The angle of ply ($\theta = 45^\circ$) for laminated plates was found to represent a lamination angle at which the minimum deflection and stresses occurred for simply supported laminated plates.
2. The amplitude values for angled-ply (45/-45/45/-45) laminated plates were less than for cross-ply (0/90/0/90) laminated plates.
3. Increasing the number of layers, the (E1/E2) ratio, or the thickness-to-length (h/a) ratio of laminated plates decreased the deflection of the laminated plates. The decrease of the aspect ratio of the plates decreased the deflection of the laminated plates.
4. The stress (σ_x) increases with an increase in the number of layers, but it decreases for both the aspect ratio (a/b) and the thickness (h), or increases the E1/E2 ratio of the laminated plates.

The results indicate that the improvements in mechanical properties of aircraft body applications were achieved.

ACKNOWLEDGEMENT

The authors would like to thank the Department of Aerospace Engineering, Faculty of Engineering, University Putra Malaysia for their assistance.

REFERENCES

- Crawford RJ (1998). *Plastics Engineering*. 3rd Edn., London, Elsevier Science.
- Decolon C (2002). *Analysis of composite structures*. New York Elsevier Science.
- Jones RM, HS Morgan (1980). Bending and extension of cross-ply laminates with different moduli in tension and compression. *Int. J. Comput. Struct.*, 11: 181-190.
- Kanagaraj S, Fa'tima R Varanda, Tatiana V Zhil'tsova, Mo'nica SA Oliveira, Jose' Simo'es (2007). Mechanical properties of high density polyethylene/carbon nanotube composites. *Int. J. Compos. Sci. Technol.*, 67: 3071-3077.
- Latheswary S, Valsarajan KV, Rao YV (2004). Behaviour of laminated composite plates using higher-order shear deformation theory. *IE(I) J.-AS.*, 85: 10-17.
- Novotny WR, Shahkarami EC, Vaziri R, Poursartip A (2007). Numerical investigation of the ballistic efficiency of multi-ply fabric armour during the early stages of impact. *Int. J. Impact. Eng.*, 34: 71-88.
- Rao KM, HR Meyer-Piening, (1990). Analysis of thick laminated anisotropic composite plates by the finite element method. *Int. J. Comput. Struct.*, 15: 185-213.
- Turvey GJ (1980). An initial flexural failure analysis of symmetrically laminated cross-ply rectangular plates. *Int. J. Solids Struct.*, 16: 451-463.
- Vasiliev V, EV Morozov (2001). *Mechanics and Analysis of Composite Materials*. UK: Elsevier Science.
- Vinson JR (2005). *Plate and Panel Structures of Isotropic, Composite and Piezoelectric Materials, Including Sandwich Construction*. Springer, USA.